

# USER MANUAL



Honeywell BW™ RigRat

LOCAL AREA GAS MONITOR

**Honeywell**



# Table of Contents

---

Honeywell BW™ RigRat .....	0
<b>Safety .....</b>	<b>6</b>
<b>Standard Contents .....</b>	<b>12</b>
<b>General Information .....</b>	<b>13</b>
Certification .....	13
General .....	14
Wireless Module Configuration .....	14
Sensor Configuration .....	14
Electrical Parameters .....	16
Type Designation .....	17
Key Features .....	19
<b>User Interface .....</b>	<b>20</b>
Display Overview .....	20
Screen Display for Various Numbers of Active Sensors .....	31
Info .....	32
<b>Mesh/LoRa Network Wireless Control .....</b>	<b>33</b>
Mesh/RF Wireless Network (if supported) .....	34
<b>Bluetooth .....</b>	<b>38</b>
Bluetooth Pairing .....	39
Broken Bluetooth Connection .....	41
Wi-Fi Connection (if supported) .....	42
Secure Wireless Communication .....	47
<b>Battery Charging .....</b>	<b>48</b>
Charging Ports .....	48
Battery States .....	53
<b>Wired Communication .....</b>	<b>54</b>
Serial (Not Intended to be Used in Explosive Atmospheres) .....	55

---

Switch .....	56
4-20mA IN .....	58
Cover Communication Ports When Not in Use .....	59
<b>External Filter .....</b>	<b>60</b>
Filter Replacement (Pumped) .....	60
Filter Replacement (Diffusion) .....	62
<b>Turning the BW RigRat On and Off .....</b>	<b>64</b>
Turning the BW RigRat On .....	64
Turning the BW RigRat Off .....	66
Testing Alarm Indicators .....	66
Calibration Status .....	67
Bump Status .....	68
<b>Modes of Operation .....</b>	<b>69</b>
Operation Mode .....	69
Menu Mode .....	69
Diagnostic Mode .....	70
Enter Diagnostic Mode .....	70
Exit Diagnostic Mode .....	72
<b>Programming .....</b>	<b>73</b>
Using Device Configurator .....	73
Security Mode .....	74
<b>Calibration and Testing .....</b>	<b>75</b>
Bump Testing and Calibration .....	75
Bump (Functional) Testing .....	75
Calibration .....	79
<b>Maintenance .....</b>	<b>80</b>
Cleaning .....	80
Antenna Installation .....	81
Removing Sensors .....	82

---

Replacing Sensors .....	83
Battery Replacement .....	83
Replacing the Pump .....	84
<b>RAEMet Sensor Installation .....</b>	<b>86</b>
Installation .....	86
<b>Alarms Overview .....</b>	<b>88</b>
Alarm Signals .....	88
Alarm Signal Summary .....	89
Manual Alarms Test .....	91
<b>Troubleshooting .....</b>	<b>92</b>
<b>Editing Features .....</b>	<b>94</b>
Error Codes .....	97
<b>Specifications .....</b>	<b>99</b>
<b>Contact Information .....</b>	<b>105</b>



# 1 Safety

## Product Registration

Register your product online by visiting:

<https://sps.honeywell.com/us/en/support/safety/hgas-product-registration>



WARNING

Warnings contain information that could prevent death or serious injury or extensive equipment damage.



CAUTION

Cautions contain information that could prevent minor or moderate injury, equipment damage, or warranty voidance.

NOTE

Notes contain helpful information.

## IMPORTANT! BUMP TEST THE MONITOR

Prior to use, every gas detection monitor should be bump tested to confirm the response of all sensors and activation of all alarms by exposing the monitor to a concentration of target gas that exceeds the low alarm set point. A bump test is also recommended if the monitor has been subjected to physical impact, liquid immersion, an Over Limit alarm event, or custody changes, or anytime the monitor's performance is in doubt.

To ensure greatest accuracy and safety, only bump test and calibrate in a fresh air environment.

The monitor should be calibrated every time it does not pass a bump test, but no less frequently than every six months, depending on use and exposure to gas and contamination, and its operational mode.

- Calibration intervals and bump test procedures may vary due to national legislation.
- Honeywell recommends using calibration gas cylinders containing the gas that is appropriate to the sensor you are using, and in the correct concentration.



**RISK OF WARRANTY INVALIDATION.** This Manual must be carefully read and understood by all individuals who have or will have the responsibility of using, maintaining, or servicing this product. The product will perform as designed only if it is used, maintained, and serviced in accordance with the manufacturer's instructions. The user should understand how to set the correct parameters and interpret the obtained results.

Any changes or modifications to this unit not expressly approved by the party responsible for compliance could void the user's authority to operate the equipment.

#### RISK OF EQUIPMENT DAMAGE

**ONLY THE COMBUSTIBLE GAS DETECTION PORTION OF THIS INSTRUMENT HAS BEEN ASSESSED FOR PERFORMANCE.**

**UNIQUEMENT, LA PORTION POUR DÉTECTOR LES GAZ COMBUSTIBLES DE CET INSTRUMENT A ÉTÉ ÉVALUÉE.**

#### RISK OF INJURY

**Warning** Substitution of components may impact intrinsic safety.

**Avertissement:** La substitution de composants peut compromettre la sécurité intrinsèque.

**WARNING:** To prevent ignition of a hazardous atmosphere, batteries must only be charged in an area known to be non-hazardous.  $U_m = 6.0V$ . Use only approved charger.

**AVERTISSEMENT:** Afin de prévenir l'inflammation d'atmosphères dangereuse, ne charger le jeu de batteries que dans des emplacement designés non dangereux.  $U_m = 6V$  Utilisez uniquement un chargeur approuvé.

Only charge the battery in safe area in the ambient temperature range  $0^{\circ}C \leq T_{amb} \leq 40^{\circ}C$ .





## RISK OF EQUIPMENT DAMAGE

- Only use the Honeywell-specified rechargeable lithium-ion battery pack supplied with the instrument.
- Charge the instrument Li-ion battery using the specifically supplied charger and only outside hazardous areas. The maximum voltage from the AC charger  $U_m$  must not exceed 6.0 VDC.
- The battery pack can only be changed in a non-hazardous area. Only use approved rechargeable battery pack P/N 500-0165-000 (or 500-0165-001 for NA certification) produced by Honeywell.
- Any data download device connected to this instrument must be approved SELV or Class 2 equipment.
- Use of non-Honeywell components will void the warranty and can compromise the safe performance of this product.
- Warning: Substitution of components may impair safe performance of this product.
- When changing the sensor configuration, ensure the operator is aware of any changes to certification restrictions.

**CAUTION:** BEFORE EACH USE, SENSITIVITY OF THE COMBUSTIBLE GAS SENSOR MUST BE TESTED ON A KNOWN CONCENTRATION OF METHANE GAS EQUIVALENT TO 20 TO 50% OF FULL-SCALE CONCENTRATION. ACCURACY MUST BE WITHIN 0 AND +20% OF ACTUAL. ACCURACY MAY BE CORRECTED BY CALIBRATION PROCEDURE.

**ATTENTION:** AVANT CHAQUE UTILISATION VERIFIER LA SENSIBILITE AVEC UNE CONCENTRATION CONNUE DE METHANE EQUIVALENTE A 20 to 50% DE LA PLEINE ECHELLE. LA PRECISION DOIT ETRE COMPRISE ENTRE 0 to 20% DE LA VALEUR VRAIE ET PEUT ETRE CORRIGEE PAR UNE PROCEDURE D'ETALONNAGE.

**CAUTION:** HIGH OFF-SCALE READINGS MAY INDICATE AN EXPLOSIVE CONCENTRATION.

**ATTENTION:** DES LECTURES SUPÉRIEURES A L'ÉCHELLE PEUVENT INDIQUER DES CONCENTRATIONS EXPLOSIVES.

## SPECIAL CONDITIONS FOR SAFE USE

- This multi-gas monitor must be calibrated if it does not pass a bump test, when a new sensor has been installed, or at least once every 60 days, depending on use and sensor exposure to poisons and contaminants
- The multi-gas monitor must be calibrated when the device is turned OFF-ON or exposed to a high concentration above the upper limit.
- The AC charger system of BW RigRat shall only be applied in non-hazardous areas by charger specifically supplied for use with the unit (for example model number ADS-25SGP-06 05717E, manufactured by HONOR Electric), approved as SELV or Class 2 equipment against IEC 60950 or an equivalent IEC standard. The maximum voltage  $U_m$  from the charger shall not exceed DC 6.0V.
- The BW RigRat enclosure has an ingress protection of rating of IP-54. The user shall ensure that the external plugs that are used are for IS charger, 4-20mA input, and ON-OFF switch will provide a degree of protection of IP-54, after they are connected to the sockets.
- Do not open when an explosive atmosphere is present.

**Note:** Users are recommended to refer to ISA -RP12.13, Part II-1987 for general information on installation, operation, and maintenance of combustible gas detection instruments. In Europe, users should refer to EN 60079-29-2.

### FCC Compliance Statement:

This device complies with part 15 of the FCC Rules. Operation is subject to the following two conditions: (1) This device may not cause harmful interference, and (2) this device must accept any interference received, including interference that may cause undesired operation.

### **Class A device:**

**NOTE:** This equipment has been tested and found to comply with the limits for a Class A digital device, pursuant to part 15 of the FCC Rules. These limits are designed to provide reasonable protection against harmful interference when the equipment is operated in a commercial environment. This equipment generates, uses, and can radiate radio frequency energy and, if not installed and used in accordance with the instruction manual, may cause harmful interference to radio communications. Operation of this equipment in a residential area is likely to cause harmful interference in which case the user will be required to correct the interference at his own expense.

MPE caution (if a FCC certified RF module is inserted in & the separation distance is indicated in the FCC grant of RF module)

To satisfy FCC / IC RF exposure requirements, a separation distance of 20 cm or more should be maintained between the antenna of this device and persons during device operation.

To ensure compliance, operations at closer than this distance is not recommended.

This device contains license-exempt transmitter(s)/receiver(s) that comply with Innovation, Science and Economic Development Canada's license-exempt RSS(s). Operation is subject to the following two conditions:

(1) This device may not cause interference.

(2) This device must accept any interference, including interference that may cause undesired operation of the device.

L'émetteur/récepteur exempt de licence contenu dans le présent appareil est conforme aux CNR d'Innovation, Sciences et Développement économique Canada applicables aux appareils radio exempts de licence. L'exploitation est autorisée aux deux conditions suivantes:

1) L'appareil ne doit pas produire de brouillage;

2) L'appareil doit accepter tout brouillage radioélectrique subi, même si le brouillage est susceptible d'en compromettre le fonctionnement.

## Proper Product Disposal At End Of Life



### **EU Directive 2012/19/EU: Waste Electrical and Electronic Equipment (WEEE)**

This symbol indicates that the product must not be disposed of as general industrial or domestic waste. This product should be disposed of through suitable WEEE disposal facilities. For more information about disposal of this product, contact your local authority, distributor, or the manufacturer.

### Sensor Specifications, Cross-Sensitivities, And Calibration Information

For information on sensor specifications, cross-sensitivities, and calibration information, refer to Technical Note TN-114: Sensor Specifications And Cross-Sensitivities. All specifications presented in this Technical Note reflect the performance of standalone sensors. Actual sensor characteristics may differ when the sensor is installed in different instruments. As sensor performance may change over time, specifications provided are for brand-new sensors.

### Make Sure Firmware Is Up To Date

For best operation, make sure your monitor is running the latest firmware.

# 2 Standard Contents

The BW RigRat is available in various user-specified configurations, each with the accessories shown below.

In addition to the instrument, the following are included:

Item	Part Number
AC adapter	W03-3044-000
LCD Cover	W03-2129-000
Diffusion calibration cap assembly*	W03-3013-000
Pump calibration tube assembly*	W03-3020-000
External Filter (Pumped version only)	W03-3006-000
QuickStart Guide	W03-4002-000
Antenna 868-928MHz, RP-N**	550-7056-000
Antenna 2.4GHz, RP-N**	550-7057-000

\* Depends on whether the model is pumped or diffusion.

\*\* Depends on wireless modem (if installed).

# 3 General Information

## Certification

Honeywell®

Hatch Pond House, 4 Stinsford Road, Nuffield Estate, Poole, Dorset, BH17 ORZ, United Kingdom

Ex ia II C/ II B T4 Ga

Ex da ia II C/ II B T4 Ga

Ex db ia II C/ II B T4 Gb



II 1G Ex ia **IC/IB** T4 G

II 1G Ex da ia **IC/IB** T4 Ga

II 2G Ex db ia **IC/IB** T4 Gb

Class I, Division 1, Groups A, B, C, & D, T4

Class I, Division 1, Groups C, & D, T4

Refer to following contents to find more information about Ex marking and permissible ambient temperature.

This apparatus is designed to be in accordance with the following Standards:

IEC60079-0:2017 Explosive atmospheres—Part 0: Equipment—General requirements;

IEC60079-11:2011 Explosive atmospheres -Part 11: Equipment protection by intrinsic safety “i”.

EN IEC60079-0:2018 Explosive atmospheres—Part 0: Equipment—General requirements;

EN 60079-11:2012 Explosive atmospheres -Part 11: Equipment protection by intrinsic safety “i”.

Performance Test:

Explosive Atmospheres – Part 29-1: Gas Detectors - Performance Requirements of Detectors for Flammable Gases [UL 60079-29-1:2019 Ed.2]

Explosive Atmospheres – Part 29-1: Gas Detectors - Performance Requirements of Detectors for Flammable Gases [CAN/CSA C22.2 NO. 60079-29-1:17 Ed.2]

## General

The BW RigRat Local Area Gas Monitor as a transportable equipment, fills the gap between portable personal detectors and fixed-infrastructure fire and gas systems. Its primary function is to alert personnel of a gas leak in their proximity, it can provide continuous measurement of gas concentrations.

The BW RigRat's main use is in temporary zone monitoring, such as repair, fence line, and inert applications where there is a possibility of a gas release.

The overall dimensions of the BW RigRat are about 396mm x 288mm x 470mm (15.6" x 11.4" x 18.5"), it consists of an enclosure, 2 rechargeable battery packs P/N 500-0165-000 (or 500-0165-001 for NA certification) as main power, 1 Li-ion rechargeable cell (P/N MS-621T) for RTC power, 1 LCD display, 4 LED indicators for light alarm, 2 buzzers for the audible alarm, 1 multi-function button, and printed circuit-board assemblies. In addition, it may also be optionally equipped with a gas-intake pump, up to 6 kinds of wireless modules in 4 wireless module slots, and up to 5 kinds of sensors in 6 sensor slots.

An AC charger connector is provided to charge battery packs in a non-hazardous area. Refer to "Specific Conditions of Use" for more information. An IS charger connector is used to connect through a safety barrier to charge one of the battery packs in hazardous areas, likewise providing the intrinsically safe power to the product.

The BW RigRat is transportable and does not require grounding (earthing). However, the circuits and the metal parts of the enclosure can still withstand a 500V dielectric test with a leakage current no more than 5mA.

## Wireless Module Configuration

Depending on the configuration, the BW RigRat may provide GPS, GNSS, Mesh, Wi-Fi, Bluetooth (BLE), LoRa, and/or NB-IoT wireless communication, the possible configurations are shown in this table:

Designator on PCB	U19	J7	J9	J8
Bluetooth (BLE)	●			
either Wi-Fi or NB-IoT			●	
either Mesh or LoRa		●		
either GPS or GNSS				●

●Optional wireless module

## Sensor Configuration

The BW RigRat may be configured with a MIPEX NDIR sensor, Dynament NDIR sensor, LEL sensor, PID sensor, and EC sensor, which are mounted inside the IP-54 BW RigRat enclosure. These sensors have been separately certified or tested according to IEC 60079. Refer to this table for more information about these sensors:

Sensor	Type	Ex marking	IECEX CoC or ExTR	Ambient temperature (°C)	Standard
EC	4R+EC	Ex ia II C T4 Ga	GB/SIR/ExTR10.0276/00	-20 to+55	IEC60079-0:2007 Edition5 IEC60079-11:2006 Edition5 IEC60079-26:2006 Edition2
MIPEX NDIR	MIPEX 02 series	Ex ia II C Ga	IECEX ITS 11.0047U Issue No.5	-55 to+60	IEC60079-0:2011 Edition:6.0 IEC60079-11:2011 Edition:6.0
Dynamment NDIR	MSH2ia ***	Ex db II C Gb	IECEX FTZU 15.0002U Issue No.2	-20 to+60	IEC60079-0:2011 Edition:6.0 IEC60079-1:2014-06 Edition:7.0 IEC60079-11:2011 Edition:6.0
PID	4R+PID	Ex ia II C T4 Ga	GB/SIR/ExTR10.0203/00	-20 to+55	IEC60079-0:2007 Edition5 IEC60079-11:2006 Edition 5 IEC60079-26:2006 Edition2
LEL Sensor (Group II, T4)	1 LEL 75 x	Ex daia II C Ga	IECEX ULD 16.0016U Issue No.1	-40 to+60	IEC60079-0:2011 Edition6 IEC60079-1:2014-06 Edition7 IEC60079-11:2011 Edition6



For possible sensor installation, refer to this table:

	Slot 1	Slot 2	Slot 3	Slot 4	Slot 5	Slot 6
MIPEX NDIR Sensor	●					
Dynamment NDIR Sensor	●	●		●	●	
PID Sensor		●				
LEL Sensor			●			
EC Sensor		●	●	●	●	●

●Sensor locations

EC Sensor: Max.5pcs

MIPEX NDIR Sensor: Max.1pc

PID Sensor: Max.1pc

LEL Sensor: Max.1pc

Dynamment NDIR Sensor: Max.3pcs

In addition, there is a noise sensor located inside of the BW RigRat, which can measure the ambient noise. The BW RigRat also contains a THP sensor in pumped version that can measure the ambient temperature, humidity, and gas flow outside.

## Electrical Parameters

The BW RigRat provides 5 external connectors with the following electrical parameters:

- AC charger connector (use only in a non-hazardous area):  $U_m=6V$
- IS charger connector:  $U_i=24V$ ,  $I_i=150mA$ ,  $P_i=1.15W$ ,  $C_i=0.36nF$ ,  $L_i=0$  (for all);  
 $U_i=12V$ ,  $I_i=500mA$ ,  $P_i=1.15W$ ,  $C_i=0.36nF$ ,  $L_i=0$  (for NA certification)
- ON-OFF switch connector:  $U_i=30V$ ,  $I_i=100mA$ ,  $P_i=0.75W$ ,  $C_i=1.1nF$ ,  $L_i=0$
- 4~20mA input connector:  $U_i=30V$ ,  $I_i=100mA$ ,  $P_i=0.75W$ ,  $C_i=0$ ,  $L_i=0$

# Type Designation

BWRR100 a-b-c

a identifies product version: D, P

D: Diffusion version (without pump)

P: Pump version

b identifies sensor configuration with regard to PID, Dynament NDIR, and LEL sensor

0: Without PID, Dynament NDIR, or LEL sensor

1: With PID sensor

2: With Dynament NDIR sensor

3: With LEL sensor

4: With PID and Dynament NDIR sensor

5: With Dynament NDIR and LEL sensor

6: With LEL and PID sensor

7: With PID, Dynament NDIR, and LEL sensor

c identifies wireless modules configuration with regard to Wi-Fi and NB-IoT

0: Without Wi-Fi or NB-IoT

1: With Wi-Fi

2: With NB-IoT

3: Fitted with Wi-Fi and NB-IoT

Depending on different configurations, the BW RigRat may refer to different types of protection, gas groups, and ambient temperatures, which are specified as below. The onerous restriction shall be taken into consideration in case one of the following is applied.

1. The first digit designates the Diffusion/Pump version. The following table details the Diffusion/pump version together with ambient temperatures.

Type	Version	Ambient Temperature (°C)
BWRR100 D-b-c	Diffusion version (without pump)	-40 to+60
BWRR100 P-b-c	Pump version	-20 to+60

2. The second digit designates the configuration of sensors with regard to PID, Dynamant NDIR, and LEL sensor. The following table details the sensor configurations together with their Ex markings and ambient temperatures:

Type	Sensor Configuration	Ex Marking (c=0)	Ambient Temperature (°C)	
BWRR100 a-0-c	without PID, Dynamant NDIR or LEL	Ex ia II C T4 Ga Class I, Division 1, Groups A, B, C, & D, T4	-40 to +60	
BWRR100 a-1-c	with PID	Ex ia II C T4 Ga Class I, Division 1, Groups A, B, C, & D, T4	-20 to +55	
BWRR100 a-2-c	with Dynamant NDIR	Ex db ia II C T4 Gb Class I, Division 1, Groups A, B, C, & D, T4	-20 to +60	
BWRR100 a-3-c	with LEL	Ex da ia II C T4 Ga Class I, Division 1, Groups A, B, C, & D, T4	-40 to +60	
BWRR100 a-4-c	with PID and Dynamant NDIR	Ex db ia II C T4 Gb Class I, Division 1, Groups A, B, C, & D, T4	-20 to +55	
BWRR100 a-5-c	with Dynamant NDIR and LEL	Ex db ia II C T4 Gb Class I, Division 1, Groups A, B, C, & D, T4	-20 to +60	
BWRR100 a-6-c	with LEL and PID	Ex da ia II C T4 Ga Class I, Division 1, Groups A, B, C, & D, T4	-20 to +55	
BWRR100 a-7-c	with PID, Dynamant NDIR and LEL	Ex db ia II C T4 Gb Class I, Division 1, Groups A, B, C, & D, T4	-20 to +55	

3. The third digit designates the configuration of wireless modules with regard to Wi-Fi and NB-IoT. The following table details the wireless module configurations together with their gas groups.

Type	Wireless Module Configuration	Gas Group	
		Zone	Division
BWRR100 a-b-0	without Wi-Fi or NB-IoT	II C	A, B, C, & D
BWRR100 a-b-1	with Wi-Fi	II B	C, & D
BWRR100 a-b-2	with NB-IoT	II B	C, & D
BWRR100 a-b-3	with Wi-Fi and NB-IoT	II B	C, & D

## Key Features

- Available pumped or diffusion
- Up to 6 gas sensor slots
- Supports Bluetooth (BLE)/ Mesh/Wi-Fi/ GPS/ LoRa
- >25days' runtime (Low Power version)
- Wide operating temperature range (-40 to 60° C)
- Rugged mechanical design

# 4 User Interface

The user interface consists of the display, LEDs, an alarm buzzer, and one multi-function button.

## Display Overview





























The backlit display provides visual feedback that includes the sensor types, readings, battery condition, and other functions.











1	Reading value	4	Correction Factor indicator
2	Communication, Pump (if installed), and battery status	5	Sensor type
3	Unit of measure	6	Alerts

## Status Indicator Icons

Status indicators tell you whether a function is operating and/or its strength or level, as well as alerts.

Icon	Function	Icon	Function
	Calibration passed		Mesh/RF Network Is Configured
	Calibration failed or overdue		Remote Alarm occur in RF Network
	Bump test passed		Mesh/RF Network Failure/Lost Connection
	Bump failed or overdue		Closed-Loop Network Is Configured
	Status		Closed-Loop Network Failure/Lost Connection
	TWA Alarm		Wi-Fi Connected (shows connection strength)
	STEL Alarm		Wi-Fi Failure
	Peak		Bluetooth (BLE) Enabled
	Gas Alarm		Bluetooth (BLE) Failure
	Inert Mode Enabled		GPS
	Pump failure		GPS Failure
	Stealth/Mute		Correction Factor
	Button Press		Battery (1 bar ≥ 10% remaining, 2 bars ≥ 50%, 3 bars ≥ 80%)
	Button Press and Hold		Battery error

<b>Icon</b>	<b>Function</b>	<b>Icon</b>	<b>Function</b>
	Mesh Wireless Signal Strength		Device Configurator app (shows when a new file is being pushed to RigRat)
	Mesh Wireless Failed		Paired with Device Configurator app (flashes when data is transferring)
	RF Network Signal Strength		Device Configurator app failure
	RF Network Failed		Data Logging

## Icon Arrangement











Status and other information icons are shown at different places on the screen: The top, the “body” (main display), and bottom.



















Here is how they are organized and located on the screen:

Top







Icon	Explanation
	Battery Alarm
	Battery Level
	Bluetooth
	GPS
	Pump
	Mesh Signal
	RF Network (LoRa) Signal
	Wi-Fi
	Menu - Disabled
	Menu - Disable Sensor Selected

## Body







Icon	Explanation
	Battery Alarm
	Low Battery
	Bump Test
	Inert Mode
	Mobile
	Network
	Peak
	Positive
	Pump
	Status
	STEL
	Stop
	Test Detect
	Test Fail
	Gas Not Detected During Test
	Test Positive









Icon	Explanation
	Test Warning
	TWA
	Waiting for Operation to Complete (animated)
	Warning!
	Correction Factor Applied

### Data Readings

Icon	Explanation
	Disabled
	High alarm
	Low alarm
	Sensor Disabled
	Peak
	STEL alarm
	TWA alarm

### Bottom

Icon	Explanation
	Alarm, <i>Displayed instead of "Heart" when there's a gas alarm</i>
	Bump Test Fail
	Bump Test Pass
	Calibration Fail
	Calibration Pass
	Click
	Hold

Icon	Explanation
	Mesh/RF Network disconnect to Host or Remote Alarm.
	Network disconnect in Closed loop or There is any device in network is alarming
	Pair Device, Device config. App. failure
	Status, heartbeat
	Stealth Mode, Buzzer mute
	Inert Mode
	Data Logging fault
	I/O in normal status
	I/O in alarm or fault status

## Design & Interface

The BW RigRat's functions are controlled via the front-panel multi-function button. The display shows information such as monitored threats, real-time readings, and measurement units, alarm type (when in alarm, including cal. overdue), battery status, datalog (if on), and radio and connection quality (if available).

### Front View

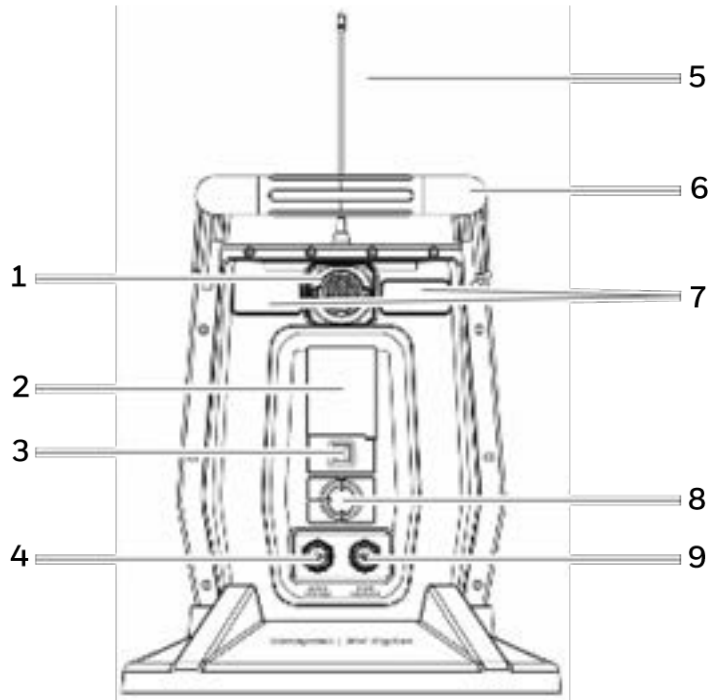

1	Noise Sensor	6	Handle
2	Display	7	Alarm LED
3	Multi-Function Button	8	Alarm Buzzer
4	AC Charge Port	9	IS Charge Port
5	Antenna		

## Rear View

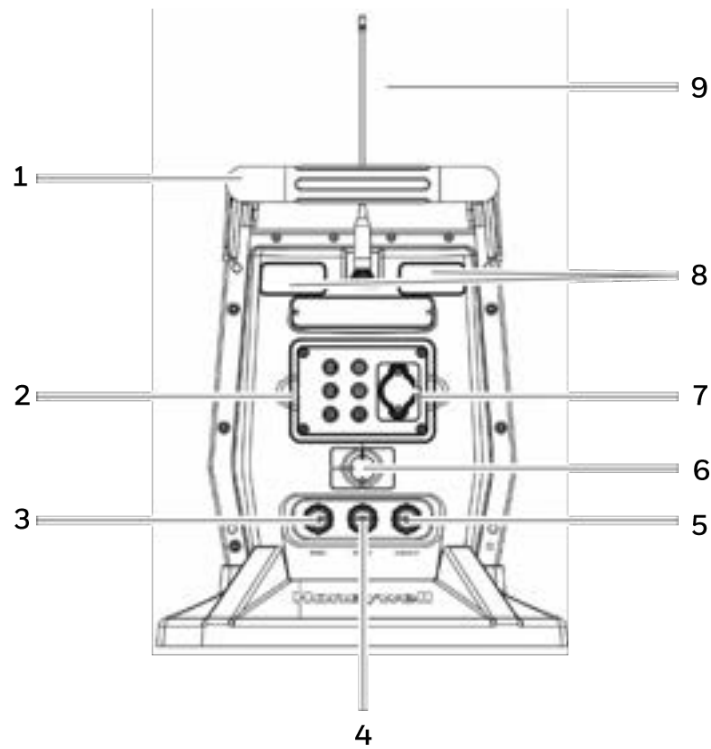

1	Handle	6	Alarm Buzzer
2	Sensor Compartment	7	Gas Inlet (Pumped Version)
3	Serial I/O Connector Port (Not intended to be used in explosive atmospheres)	8	Alarm LED
4	I/O Connector Switch Port	9	Antenna
5	4-20mA In Connector Port		

In addition to turning the instrument on and off, the multi-function button can be used to control different parameters and make selections within the instrument's menus. Also, pressing the button activates display backlighting when it is off: Press the button once when the backlighting is off to turn it on.





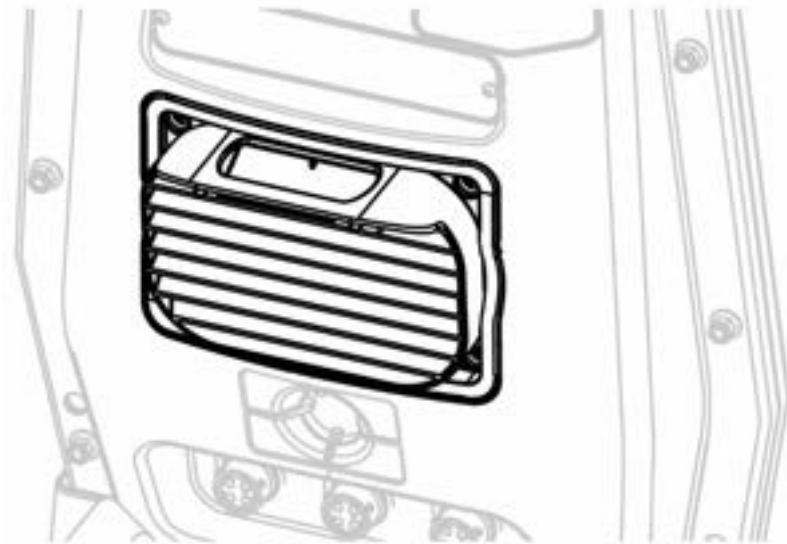







## Rain Protector (Optional)

The optional Rain Protector (P/N: W03-2038-000) presses into place over the sensor compartment. It protects the sensors from rain and large debris. It easily pulls off when you need to access the sensor compartment.



## Screen Display for Various Numbers of Active Sensors

The BW RigRat can accommodate from one to six sensors. When one or more sensors is either not installed or turned off, the display only shows the installed, active sensors. If one is turned off, it is shown in gray.

00:00AM		00:00AM	
<b>400</b> ppm CO2		<b>400</b> ppm CO2	
<b>0.0</b> ppm VOC 		<b>0.0</b> ppm VOC 	
<b>0</b> %LEL LEL 		<b>0</b> %LEL LEL 	
<b>20.9</b> % OXY		<b>20.9</b> % OXY	
<b>0</b> ppm CO		<b>0</b> ppm CO	
<b>0.0</b> ppm H2S		<b>0.0</b> ppm H2S	
  		  	



# Info

The info screens are easy to step through by pressing the button once to advance from one to the next. Hold the button down for secondary actions.

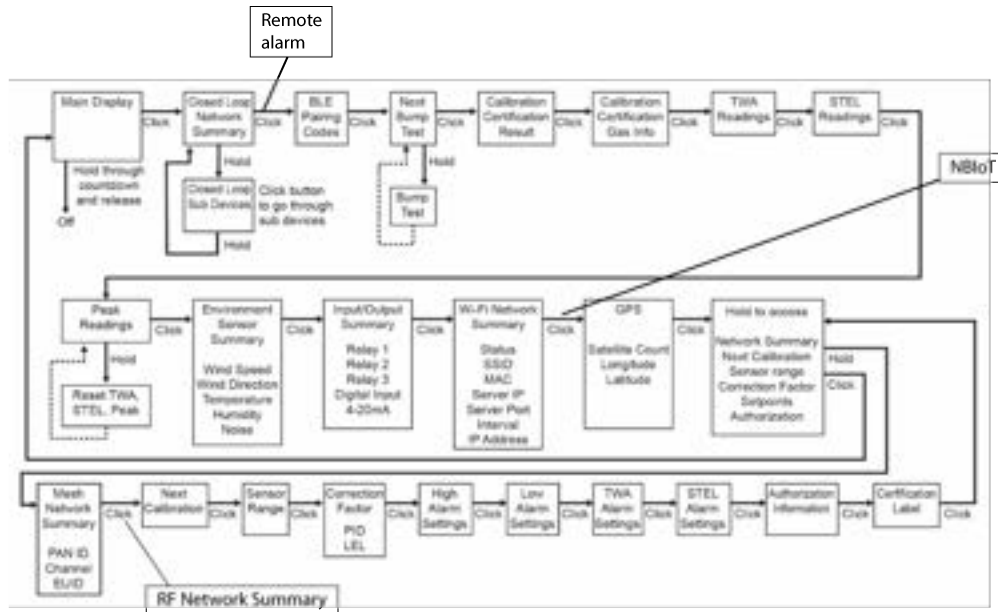

**Note:** In most cases, if no buttons are pressed at any of the menu steps for 60 seconds, the instrument reverts to the main display.

# 5

## Mesh/LoRa Network Wireless Control

### Mesh/LoRa Network Wireless Control and Submenus

When you step through the main menu, as shown in the Menus diagram, there is a screen for wireless communication, containing information on wireless settings and status.

**Note:** Wireless settings are only present if the BW RigRat is equipped with a Mesh/LoRa Network wireless module. Settings are managed through the Device Configurator app, under the “Wireless” heading.

Settings include:

- Mesh: Enable/Disable
- Pan ID: 1 to 999
- Channel: select
- Interval: select
- Off-Network Alarm: On/Off
- Network Mode: Router/STD/Close Loop
- RF: Enable/Disable
- Pan ID: 1 to 999
- Channel: select
- Interval: select
- Off-Network Alarm: On/Off
- Network Mode: Router/STD



Wireless Mesh/RF Radio equipped models (that is, not Wi-Fi) allow you to check communication with other wireless devices and get other useful information about the wireless settings.

# Mesh/RF Wireless Network (if supported)

## Mesh Closed-Loop Network

**Note:** If the BW RigRat is used as a repeater without sensors, it will display a blank screen.

- Use the Device Configurator app to set all BW RigRat instruments' mesh wireless Network Mode to Closed Loop.
- Set all BW RigRat instruments' mesh wireless PAN ID/Channel so that they are all the same.
- The BW RigRat instruments can now connect to each other.
- The following are shown on the BW RigRat LCD:

- Mesh icon: 
- Network status: Not in network or remote device is in alarm  or in network 
- At the Mesh Network Summary screen, you can find more other BW RigRat status information.

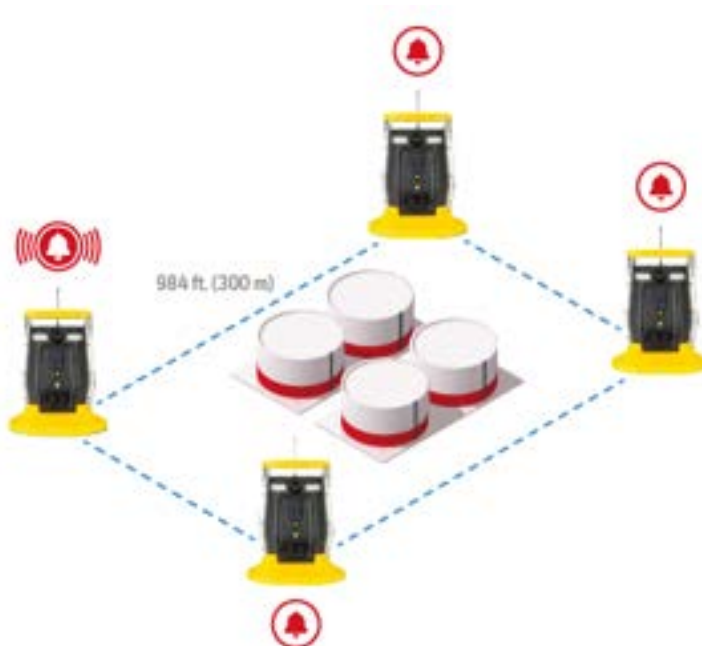

## Mesh Connect to Controller

- Set the BW RigRat instruments' mesh wireless Network Mode to STD or Router by using the Device Configurator app.
- Set the BW RigRat, Portable devices, Mesh Router, and Controller to have the same PAN ID/Channel.
- The network is now ready. The BW RigRat instruments will show on the Controller display.

**Note:** A router can bypass data. STD cannot bypass data, and can only act as an end device. Enabling Router will cause the BW RigRat to consume more energy and decrease overall runtime before recharging is necessary.



Mesh 868/915MHz



Mesh 2.4GHz

## Mesh Connect to Radiant Reader

- Set the BW RigRat instruments' mesh wireless Network Mode to STD or RTR by using the Device Configurator app.
- Set the BW RigRat PAN ID/Channel to be the same as those in Radiant Reader.
- The BW RigRat now joins the network and can show information on PC software.



**Note:** A router can bypass data. STD cannot bypass data, and can only act as an end device. Enabling Router will cause the BW RigRat to consume more energy and decrease overall runtime before recharging is necessary.

## RF Network (LoRa) Connect to Central Hub

Set the BW RigRat instruments' RF wireless Network Mode to STD or RTR by using the Device Configurator app.

Set the BW RigRat PAN ID/Channel to match those in Central Hub.

The BW RigRat is now able to join the network and can show information on Safety Suite software.



# 6 Bluetooth

The BW RigRat is always equipped with a BLE (Bluetooth Low Energy) module, it is easy to use the app on a smartphone or tablet to perform setup functions.



# Bluetooth Pairing

Follow the device pairing instructions in Device Configurator. You will need to have the BW RigRat on and showing the Bluetooth Pairing Codes screen. Using the app, you will be given a guide to inputting the confirmation number on the BW RigRat's screen. Type the pairing code into mobile app to pair the instrument and the smartphone/mobile app.

## Pairing BW RigRat with Mobile Device

1. Make sure the Bluetooth is turned on on the mobile device.
2. Push the BW RigRat button to wake up the display.
3. In Settings on the mobile device, select Bluetooth.
4. Select the BW RigRat.
5. Check the BW RigRat screen for the pairing code.
6. Enter the pairing code into the mobile device.

## Connect a BW RigRat to Device Configurator (DC):

- Open Device Configurator.
- Select the Device List menu.
- Push the BW RigRat button to wake up the display.
- Click "Scan" to search for a nearby BW RigRat.
- Select the BW RigRat (text such as "BW RigRat No, HRRD0009001" is printed on the nameplate or on display's "BLE pairing codes" screen).
- The BW RigRat display will show a pairing code on its bottom line. Input this code in the app's dialog box.
- Input the password in the second dialog box. The default is 0000.
- Now the BW RigRat (for example, BW RigRat HRRD0009001) is connected.

- The BW RigRat display now shows this icon: 

## Disconnect a BW RigRat in DC:

- Click the connected BW RigRat icon  on the Paired Devices screen.
- Click Unpair to disconnect this BW RigRat.

## Connect to another BW RigRat in DC:



- Disconnect the connected BW RigRat first.
- Scan and select another BW RigRat in the Available Devices list.
- Connect it. Refer to the above steps in Connect a BW RigRat to Device Configurator (DC).

**Note:** The BW RigRat LCD must be at the main screen when working with the Device Configurator app.

**Important!** Uploading a configuration to a BW RigRat is not possible when the device is in gas alarm or when the battery is near empty.

## Broken Bluetooth Connection

Sometimes a Bluetooth connection can be disconnected. This can occur if there is too much interference, or if the smartphone running the monitoring app is turned off or goes out of Bluetooth range. When this happens, the Mobile Connection icon is not shown on the BW RigRat display.

Check for interference (too many Bluetooth communications nearby, too much distance between the BW RigRat and the smartphone). You may need to turn off the BW RigRat and exit the app, and then restart both and re-pair.

**Note:** The Bluetooth connection between a smartphone and a BW RigRat is best within a distance of 5 meters. The BW RigRat's Bluetooth will automatically shut down in 15 minutes if no operation is performed. It is necessary to push the button to wake the BW RigRat Bluetooth, which will then be detected by a smartphone.

## Wi-Fi Connection (if supported)

BW RigRat Wi-Fi is designed to operate on a wireless network anchored by Safety Suite Real Time (SSRT) monitoring software and using Wi-Fi access points. Operational distance between the instrument and the access point (wireless router) varies, depending on such factors as interference and obstacles. It uses the 802.11b/g/n protocol using the 2.4GHz ISM (license-free) frequency band.

**Note:** To ensure the best communication, it is recommended that the Wi-Fi-equipped instruments and access point not be located close to microwave ovens, cordless telephones, or Bluetooth devices.



## Secure Wireless Access Point Configuration

If Wi-Fi is enabled, a BW RigRat uses a Wi-Fi wireless network to transmit data related to its current and past activity. To protect these data against unauthorized access, Honeywell recommends the following when configuring your wireless network:

- Set a unique network name (SSID). Do not use the default name.
- Set unique administrative credentials (username and password) that control the configuration settings of your Access Point / Router / Gateway. Do not use the default credentials. Use a strong password (see Strong Password Tips).
- Configure strong authentication and encryption in your network. Honeywell recommends WPA2 Personal (aka WPA2-PSK) with AES encryption.
- Create a strong network passphrase (see strong password tips). Do not use the default passphrase.
- Maintain the firmware of your Access Point / Router / Gateway as well as the firmware of all devices connected to the wireless network up to date.

## Setting Wi-Fi Communication Parameters in Device Configurator App

Wi-Fi-equipped instruments' parameters for communication must be set in Device Configurator app.

### Wi-Fi

You can enable or disable Wi-Fi.

### Mac Address

Select "Use Static IP Address" if you have a static IP or "Use DHCP" if your system allows dynamic hosting configuration. Check with your system administrator to determine which is appropriate for your network.

If you use a static IP address, you must provide the Static IP address, Gateway, and Subnet Mask. If you are using DHCP, you do not have to provide these, because they will be filled in automatically.

### Channels and Security

Check with your system administrator for the settings in this section.

### Security Mode

Different types of wireless security guard your network against possible instances of unauthorized access. Using security, you can:

- Ensure that no one can easily connect to your wireless network without permission
- Personalize access regarding who can configure your wireless settings
- Protect all data that is transmitted through the wireless network

Check with your system administrator for the wireless security mode you should use.

Use the drop-down menu to select the type of security.

Then set your Security Key.

**Warning!** Using a network with security disabled is not recommended.

## Security Key

Depending on the type of security you choose, your key will have to be a different number of characters.

### IMPORTANT!

Configure strong authentication and encryption in your network. WPA2 Personal (also known as WPA2-PSK) with AES encryption is highly recommended.

Here are characteristics of the different types, their relative security strength, and the number of characters needed in the key:

Security type	Security rank	Number of characters
WEP (Wired Equivalent Protocol)	Basic	40/64-bit (10 characters) 128-bit (26 characters)
WPA Personal Wi-Fi Protected Access Personal	Strong	8 to 63 characters
WPA2 Personal Wi-Fi Protected Access 2 Personal	Strongest	8 to 63 characters
WPA2/WPA Mixed Mode	WPA2: Strongest WPA: Strong	8 to 63 characters

### Strong Password Tips

- Use a unique password. Do not reuse passwords used in other systems or for other purposes. Avoid using examples found on the Internet, in literature etc.
- Use a long sequence of random characters (at least eight characters).
- Use a mix of different types of characters, such as uppercase and lowercase letters, numbers, punctuation marks, etc.
- To make the password easier to remember, begin with a sentence, verse, book title, line from a song etc. Omit or change certain letters. For example, use only the first few letters from each word, replace some letters with numbers or punctuation marks (for example replace all letters “a” with dots “.”), etc.
- Avoid using easily guessable phrases, like names, words found in dictionaries, years, birthdays, phone numbers, etc.
- Avoid using the most popular passwords, such as “123456”, “qwerty”, “password” etc. Also avoid using them even in modified formats, such as “QWErty” or “Pa55w0rD”.
- Protect the password while archived. Use trusted and properly configured password vaults for this purpose.

## SSID

The SSID (Service Set Identifier) is a case-sensitive unique identifier attached to the header of packets sent over a wireless local-area network. Each wireless network in your range will have its own SSID. Consult with your IT department for the SSID.

### **Server IP**

This is the destination IP address for the instrument to communicate with a computer running Safety Suite Device Configurator (SSDC).

### **Server Port**

The port number is distinct from any physical port on a computer such as a COM port or an I/O port address. It is a 16-bit address that exists only for the purpose of passing certain types of information to the correct location above the transport layer of the protocol stack.

### **Test the Wi-Fi Operation**

Test the BW RigRat in your network to ensure that it communicates properly. Always do this after performing any changes to wireless parameters.

## Secure Wireless Communication

Secure communication between a BW RigRat and the server via Mesh/RF or Wi-Fi connection or mesh closed-loop connection can be configured with the Device Configurator app in the General Settings Mesh Security page. It can be configured to enable or disable the encryption, and the secure keys can be changed. The Network Preshared Key is 32 characters long, and the Mesh User Key is 4 characters.

- For Mesh/RF or Wi-Fi connection to the server, both the BW RigRat and the server must have the same Network Preshared Key.
- For Mesh Closed Loop connection, all BW RigRat devices in the same network must have the same Network Preshared Key and Mesh User Key.

**Note:** The server must be running the latest version of Safety Suite Device Configurator (SSDC) to support secure communication.



# 7

## Battery Charging

Always fully charge the battery before using the BW RigRat. Its Li-ion batteries are charged by connecting the instrument to its charger (P/N: W03-3044-000) and then plugging the charger into an AC power source. In safe settings, use the AC Charge input with the included power adapter.

### Charging Ports

There are two charging ports:

- AC Charging, Safe Area (left port)
- Intrinsically Safe Charging For Hazardous Areas (right port)

Remove the cover for the appropriate port by turning it counterclockwise:

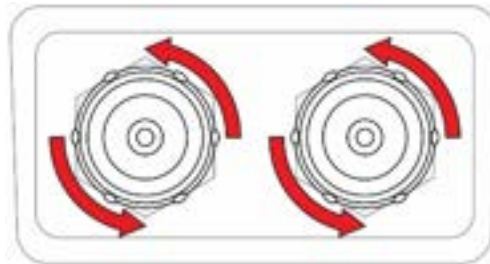

Note that the ports have different pin configurations and therefore require different cables for connection.

#### IMPORTANT!

Make sure the cable connector is tight. Finger-tighten the connectors, but do not use tools.

Align the connector and plug and then press in and turn the ring until it clicks.

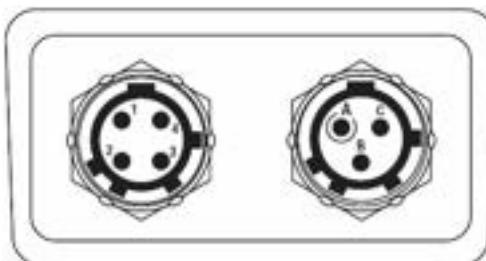

## AC Charging, Safe Area

For charging in safe areas, use the AC/DC adapter (P/N: W03-3044-000). Remove the dust cap on the port labeled AC CHG SAFE AREA, align the indexing pins on the connectors, press in, and then turn the ring until it clicks.

### IMPORTANT!

Make sure the cable connector is tight. Finger-tighten the connectors, but do not use tools.

It is strongly suggested to turn off the BW RigRat while charging on the AC charger. Running the BW RigRat while charging results in a longer charging time.

### WARNING!

Do not charge the BW RigRat with the AC charger in a hazardous area! Always charge the BW RigRat with the AC charger in a safe area.



AC CHG SAFE AREA		
PIN 1	VDD	Charger port, positive, input, rated 5.7VDC/3A
PIN 2	Reserved	HW Reset
PIN 3	CHG_STA	Charging status indicate, output, In-charging/full-charged
PIN 4	GND	Charger port, negative

## Intrinsically Safe Runtime Extension for Hazardous Areas

If the BW RigRat is to be charged or powered in a hazardous area, then an intrinsically safe (I.S.) barrier box is necessary. Use P/N: W03-3018-000, and connect it to the IS CHG HAZARDOUS port.

**Note:** The intrinsically safe line power is only providing runtime extension.

Requirements:

- W03-3018-000 I.S. barrier, 110~230VAC/50~60Hz IN, 23.5VDC/1.15W OUT
- W03-2168-000 I.S. barrier extension cable, 100 m, 3-pin plug

Schematic drawing shows how the IS Barrier is configured with the BW RigRat:

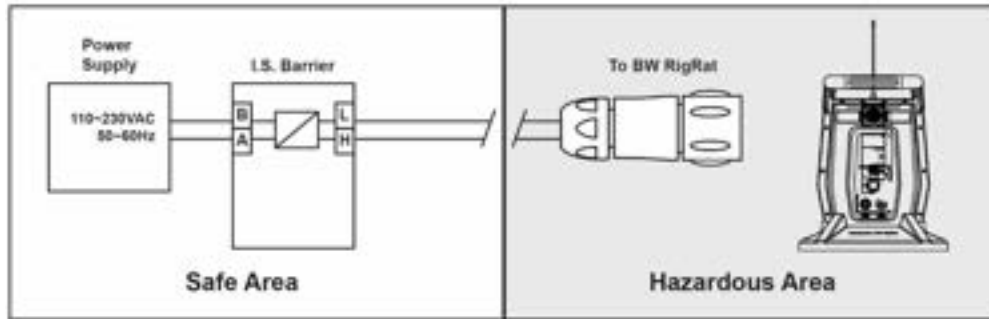

Intrinsically safe barrier terminals in use

IS Barrier		
Terminal A	-	Safe area, power negative input
Terminal B	+	Safe area, power positive input, rated 110~230VAC
Terminal H	-	To hazardous area, negative output
Terminal L	+	To hazardous area, positive output, max 23.5V/1.15W

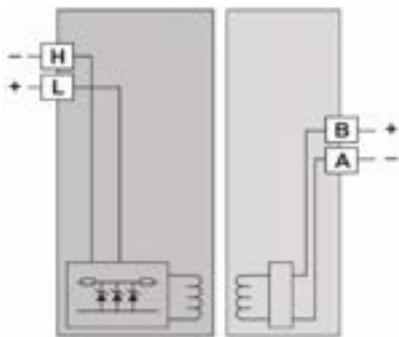

Matched plug (P/N: 400-4105-003)

IS barrier parameters:

Input	Rated 110~230VAC/50~60Hz
Consumption	$\leq 3W$
Output (to hazardous area)	$U_o=23.5V;$ $I_o=150mA;$ $P_o=1.15W;$ $C_o=132nF;$ $L_o=1.5mH$
Operating Temp.	-20 to 60 °C
Relative humidity	5 to 95% without condensing
Installation	In safe area

---

Extension cable (W03-2168-000)

W03-2168-000 IS barrier to BW RigRat cable, 100meters, with 3-pin connector.

Total 100m cable IS parameters: (C=80pF/m; L=0.7uH/m; R=23.2mΩ/m)

Ct=8nF

Lt=0.07mH

---

BW RigRat IS parameters in hazardous area:

Ui=24V

Ii= 150 mA

Pi=1.15W

Ci=0.36nF.

Li=0uH

---

For hazardous applications, these conditions must be met:

$U_o \leq U_i$

$I_o \leq I_i$

$P_o \leq P_i$

$C_o \geq C_i + C_t$

$L_o \geq L_i + L_t$

Uo/Io/Po/Co/Lo are IS barrier output parameters

Ui/Ii/Pi/Ci/Li are RigRat input parameters

Ct/Lt are extension cable additional parameters

+	IS barrier output, positive
-	IS barrier output, negative
NC	Not connect

## Cover Ports When Not in Use

Whenever a port is not in use, make sure the port is covered. This keeps the contacts clean and prevents inadvertent short-circuiting. Finger-tighten the covers, but do not use tools.

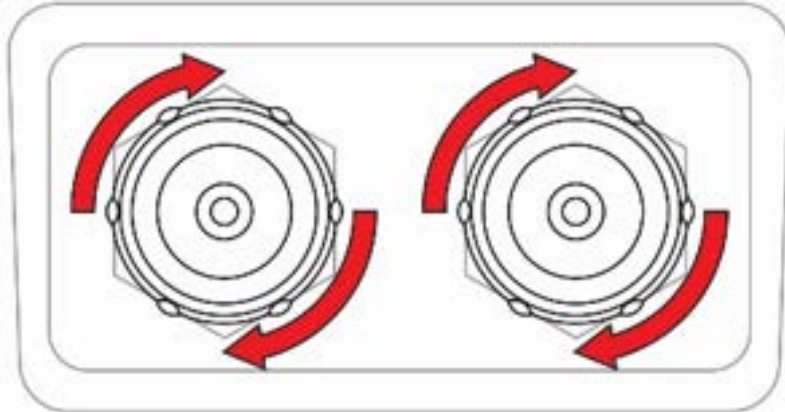





**To reduce the risk of ignition of hazardous atmospheres, recharge, remove, or replace the battery only in an area known to be non-hazardous! Recharging the battery pack can be performed in hazardous area only via IS charge port.**

When power is applied and the BW RigRat battery is charging. When the battery is fully charged, the Full Charge icon is shown accompanied by "100%." If the instrument is off but is being charged, it shows the charge state and percentage.

# Battery States

The battery icon on the display shows how much charge is in the battery and alerts you to any charging problems.

			
Battery Low	≥10%	≥50%	≥80%

When the battery power is critically low, the instrument displays a warning that it will be shutting off:

**Low power  
0% battery remaining**



**Powering off...**

---

The instrument automatically powers down and you will need to recharge the battery before placing the instrument into service again.

## 8

## Wired Communication

The BW RigRat has three ports for external communication. They are labeled as:

- Serial (not intended to be used in explosive atmospheres) (a)
- Switch (b)
- 4-20mA IN (c)

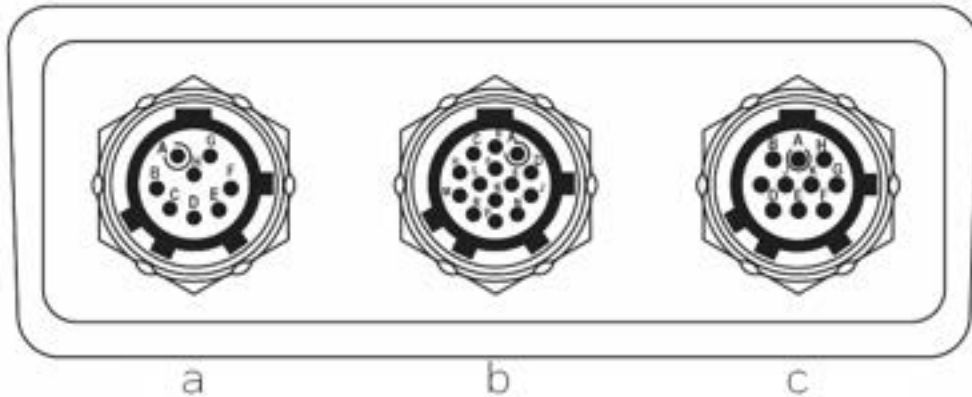

## Serial (Not Intended to be Used in Explosive Atmospheres)

The Serial port is designed to be the interface point with an optional RAEMet meteorological sensor.

<b>Pin</b>		
Pin A	VCC	Power output, rated 4VDC
Pin B	CS	Chip select, output
Pin D	RX	UART port, output
Pin E	GND	Ground
Pin F	TX	UART port, input
Others		Reserved

**Note:** See "RAEMet Sensor Installation" on page 86 for more information. and details on connecting to a RAEMet Sensor.



# Switch

BW RigRat supports three separate SPST PhotoMOS relay output switch connections for applications where other equipment needs to be controlled (lights, sirens, etc.).

## Relay Definitions:

- Relay 1 Any gas sensor failed, or STEL/TWA/+OL/-OL alarms
- Relay 2 Any high alarms
- Relay 3 Any low alarms

**IMPORTANT!** This is a fixed configuration that can only be modified via Device Configurator app.

**Note:** Driving high current or voltage through the switch will damage the product.

**Note:** The default option is NO (normally open). It can be set to NC (normally closed) via the Device Configurator app. Note that NC consumes more battery current.

PhotoMOS relay output switch parameters		
Must meet IS parameters if used in hazardous area!		
Item	Value	Note
Voltage	30V	AC/DC
Max power consumption on switch	0.75W	
Continuous load current	100mA	
On resistance	1Ω typical	

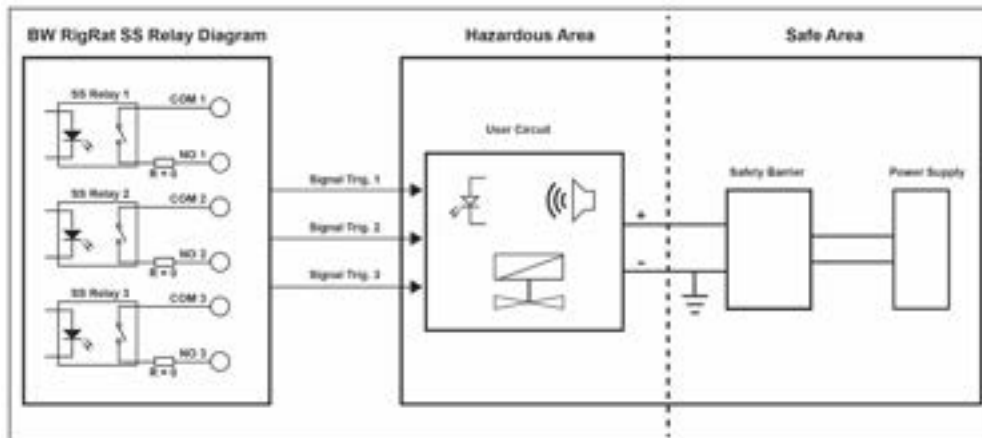



**SWITCH**

PIN A	NO1	Solid-state relay 1, NO
PIN B	COM1	Solid-state relay 1, COM
PIN H	NO2	Solid-state relay 2, NO
PIN J	COM2	Solid-state relay 2, COM
PIN M	NO3	Solid-state relay 3, NO
PIN N	COM3	Solid-state relay 3, COM
Others	Reserved	



Matched plug (P/N: 400-4105-014)

For hazardous applications, the system should meet these parameters:

- $U_o \leq U_i$
- $I_o \leq I_i$
- $P_o \leq P_i$
- $C_o \geq C_i + C_t$
- $L_o \geq L_i + L_t$
- $U_o/I_o/P_o/C_o/L_o$  are IS barrier output parameters;
- $U_i/I_i/P_i/C_i/L_i$  are RigRat input parameters;
- $C_t/L_t$  are extension cable additional parameters.

BW RigRat switch port IS parameters:

- $U_i=30V$
- $I_i= 100mA$
- $P_i=0.75W$
- $C_i=1.1nF$
- $L_i=0uH$

# 4-20mA IN

The BW RigRat supports a 4-20mA signal input and a no source switch on/off signal input. When 4-20mA input, BW RigRat will check and show the current, also will give an alarm when out of limitation value. When switch signal input, BW RigRat will alarm when switch on. This is for emergency alarm.

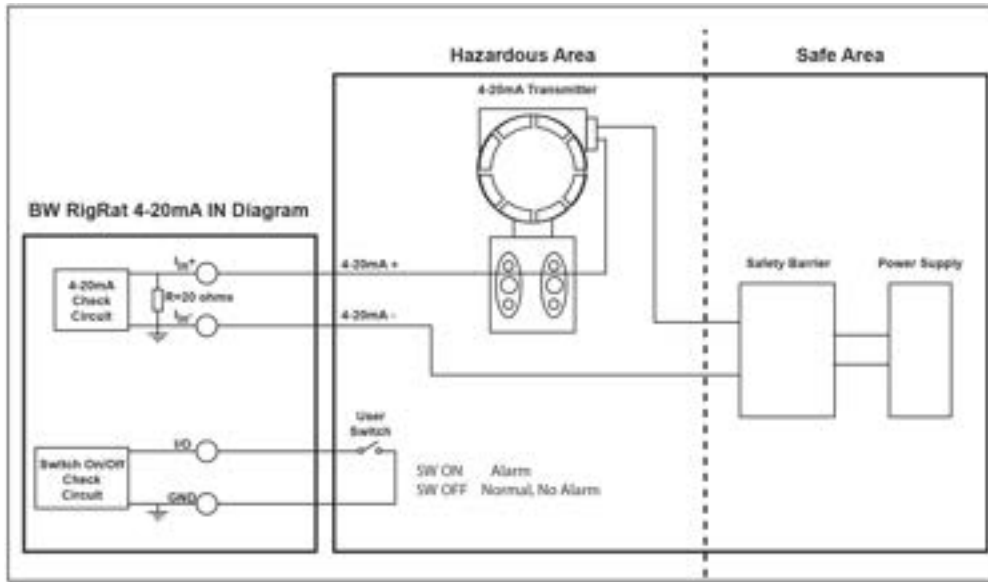

4-20mA IN

4-20mA IN		
PIN A	GND	Switch input, GND
PIN B	I/O	Switch input, signal
PIN D	lin+	4-20mA input positive
PIN E	lin-	4-20mA input negative
Others	Reserved	



Matched plug (P/N: 400-4105-010)

For hazardous applications, the following must be met:

- $U_o \leq U_i$
- $I_o \leq I_i$
- $P_o \leq P_i$
- $C_o \geq C_i + C_t$
- $L_o \geq L_i + L_t$
- $U_o/I_o/P_o/C_o/L_o$  are IS barrier output parameters;
- $U_i/I_i/P_i/C_i/L_i$  are RigRat input parameters;
- $C_t/L_t$  are extension cable additional parameters.

BW RigRat switch port IS parameters:

- $U_i=30V$
- $I_i= 100mA$
- $P_i=0.75W$
- $C_i=0nF.$
- $L_i=0uH$

## Cover Communication Ports When Not in Use

Whenever a port is not in use, make sure the port is covered. This keeps the contacts clean and prevents inadvertent short-circuiting. Finger-tighten the covers, but do not use tools.

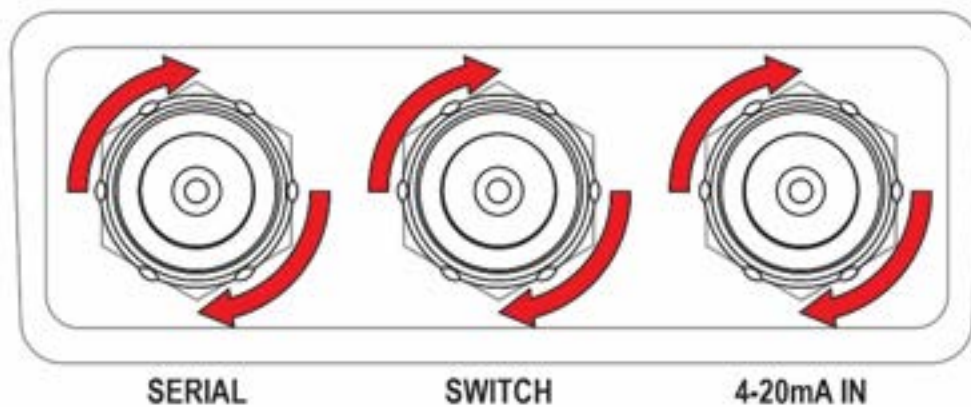

# 9

## External Filter

The External Filter (P/N: W03-3006-000) is designed to prevent debris from entering the BW RigRat in dirty or dusty environments. Replace the filter when it appears dirty.

### Filter Replacement (Pumped)

The external filter is located on the rear of the BW RigRat:

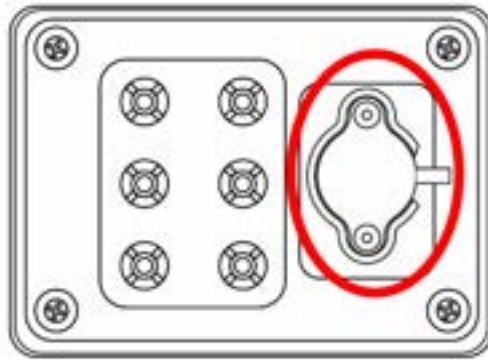

1. Turn off the BW RigRat.
2. Loosen the two Philips screws that secure the filter.

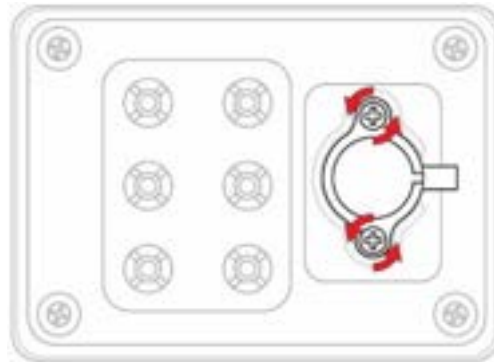

3. Lift the filter out of its docking area.

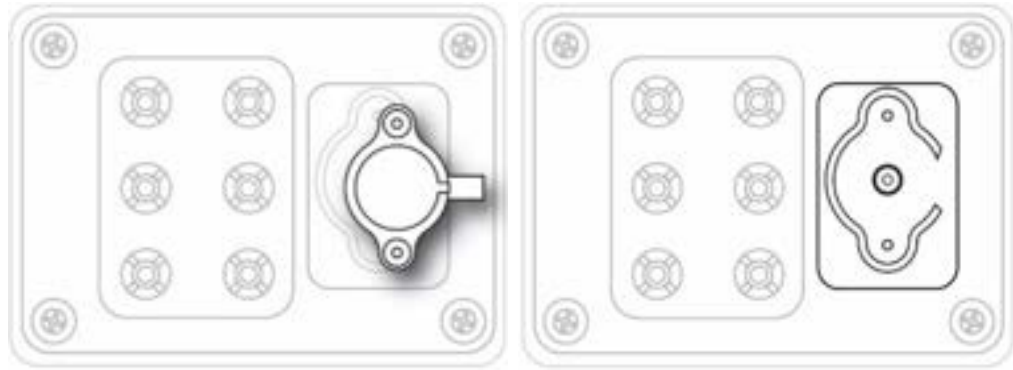

4. Dispose of the old filter properly.
5. Press a new filter into place.
6. Replace and tighten the two Philips screws. Do not overtighten.

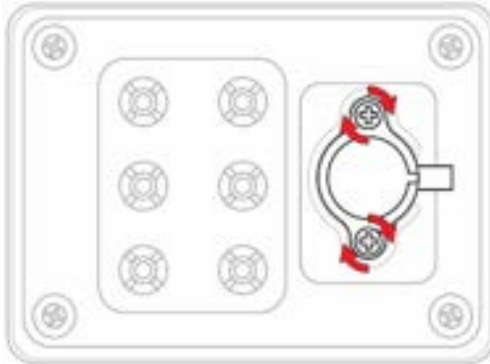

## Filter Replacement (Diffusion)

If the filters over the sensors appear dirty, replace them. The external filters are located inside the panel on the rear of the BW RigRat:

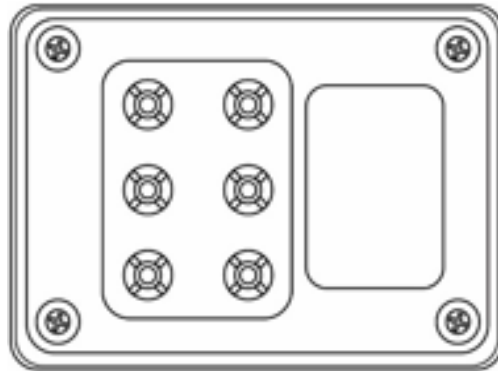

1. Turn off the BW RigRat.
2. Remove the Rain Protector (if installed).



3. Remove the four screws that hold the Sensor Cover in place.
4. Carefully take out the O-rings in each sensor location on the plate.
5. Remove the current filters.

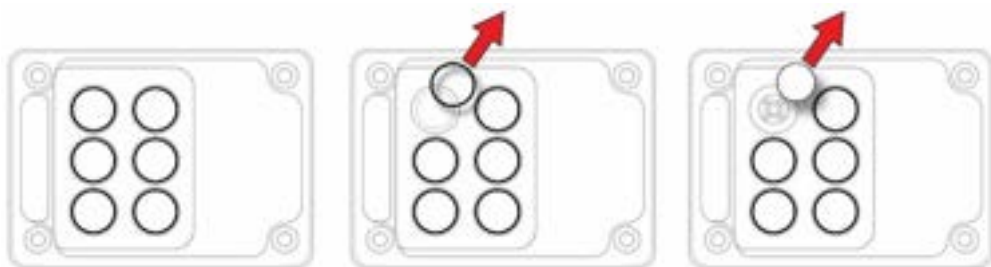

6. Place new filters (P/N: M01-2067-000) into each of the six locations.
7. Place the O-rings back in their original locations.

8. Put the plate back in place.
9. Tighten the four screws.
10. Replace the Rain Protector (if needed).

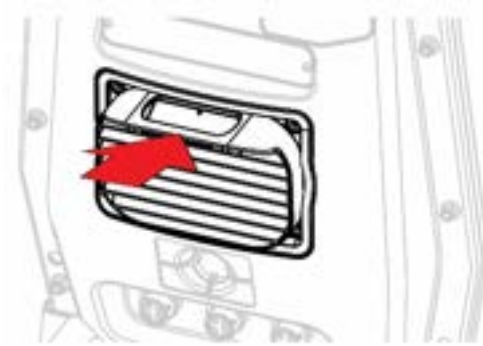



# 10

## Turning the BW RigRat On and Off

### Turning the BW RigRat On

With the instrument turned off, press and hold the button until LCD display starts a countdown, and then release. During startup, the battery, buzzer, and LEDs are tested, and then it performs self-testing of its other functions. When the main measurement screen appears, the instrument is ready for calibration or use.

**Note:** The type number is given on the LCD display during startup, refer to clause 2 for more details about use restriction.

**Note:** When the battery's charge falls below a preset voltage, the instrument warns you by showing a critical error message, and turn off automatically in 3 seconds. You should charge the battery before turning it on again.

#### IMPORTANT!

If a major error that prevents the BW RigRat from functioning is found during startup, the message "Contact Service" is shown on the display. The instrument should be shut off and serviced.

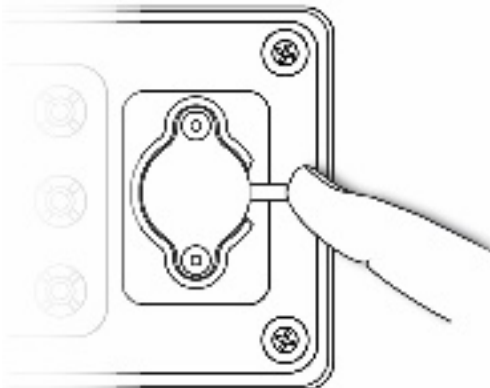

**Note:** During a pumped BW RigRat's startup, startup pauses and the display instructs you to place your finger over the pump inlet to test the pump. Leave the inlet covered until instructed to remove your finger.

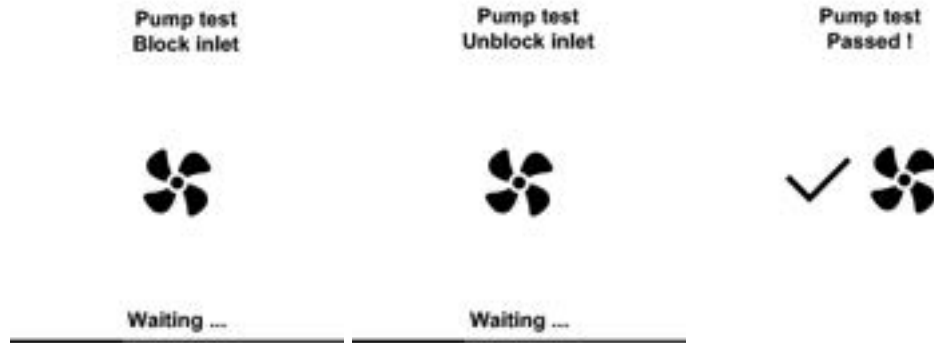



During startup, sensors and functions are checked. Also, if sensors are overdue for a bump test or calibration, either or both of these screens will be displayed to alert you:

Calibration Overdue			Bump test Overdue		
LELIR ☹	-360	days	LELIR ☹	-1	days
OXY	-360	days	OXY	1	days
CO	30	days	CO	-1	days
CO2	360	days	CO2	!	days
SO2	30	days	SO2	1	days
H2S	30	days	H2S	1	days

 CLICK to acknowledge
  CLICK to acknowledge

**Note:** If you do not click the button to acknowledge being informed of overdue tests, the instrument will shut itself off in 300 seconds (5 minutes).

## Turning the BW RigRat Off

At the main measurement screen, press and hold the button. A 3-second countdown to shutoff begins. After that, another 3-second countdown to enter the menu begins. You must release the button during the second 3-second countdown to shut off the instrument. The screen displays “OFF” for 3 seconds, and then the instrument is off. If you release the button during the first 3-second countdown, the instrument continues normal operation.

**Note:** if you continue to hold the button during the second 3-second countdown, it enters the main menu.

**Note:** You cannot turn off the BW RigRat if it is in gas alarm.

## Testing Alarm Indicators



Under normal-operation mode and non-alarm conditions, the backlight can be tested by turning the instrument on. If you perform a bump test, the buzzers and LEDs are tested.



### **IMPORTANT!**

If any alarm does not respond, check alarm settings to make sure all alarms are enabled. If any alarms are enabled but not functional, the instrument should not be used.

# Calibration Status

If any sensor requires calibration, then you are alerted on the screen during startup, and the sensor requiring calibration is shown in red:

Calibration Overdue			Next Calibration		
LELIR 	-360	days	LELIR 	360	days
OXY	-360	days	OXY	360	days
CO	30	days	CO	360	days
CO2	360	days	CO2	360	days
SO2	30	days	SO2	360	days
H2S	30	days	H2S	360	days

 CLICK to acknowledge
  CLICK to skip

Calibration is required if:

- The sensor module has been replaced with one whose calibration is overdue.
- The defined period of time between calibrations has been exceeded, according to the policy set for the instrument.
- If you have changed the calibration gas type without recalibrating the instrument.
- The sensor has failed a previous calibration.

# Bump Status

If any sensor requires a bump test, then during startup, the screen displays “Bump Overdue,” with a list of those sensors shown in red:

Bump test Overdue			Next Bump Test		
LELIR	-1	days	LELIR	1	days
OXY	1	days	OXY	1	days
CO	-1	days	CO	1	days
CO2		days	CO2	1	days
SO2	1	days	SO2	1	days
H2S	1	days	H2S	1	days

CLICK to acknowledge     
 HOLD to start bump test

A bump test is required if the defined period of time between bump tests has been exceeded. This interval is set by an administrator using Device Configurator.

# 11 Modes of Operation

The BW RigRat has three modes, Operation Mode, Menu Mode, and Diagnostic Mode.

## Operation Mode

Menus in Operation Mode are easy to step through by pressing the button.

**Note:** There is only one button.

**Note:** There are two types of button presses: Short press (Click) and longer press (Hold).

## Menu Mode

In Menu Mode, the BW RigRat provides access to start calibration, enable/disable sensors, and enter Mesh Network Assistant.

This mode can only be accessed with the instrument turned on and then holding the button down through the 3-2-1 countdown, followed by a second 3-2-1 countdown.

### Entering Menu Mode

1. With the BW RigRat on, hold the button down through the 3-2-1 countdown, followed by a second 3-2-1 countdown.
2. The password screen appears, release the key.
3. Enter the 4-digit password (the default password is 0000).
  - Step from one position in the four-character string to the other by holding the button down.
  - Press the button repeatedly to select a desired number. Numbers increase from 0 to 9.
  - Once 9 is reached, pressing again “wraps” around back to 0.
4. When you are done, hold down the button. If you input the correct password, you receive access.

## Start Calibration

Initiate a calibration by holding the button. Calibration will begin with fresh air calibration. Follow the instructions on the screen for other calibrations.

## Enable/Disable Sensors

You can individually enable or disable a sensor.

1. Press the button to scroll through the sensors.
2. Hold the button down to enable/disable a selected sensor.

## Mesh Network Assistant

The screen shows these:

Unit ID

Signal quality

Ping Tx

Ping Rx

Signal quality shows how well signal is being received. Ping Tx (Ping transmission) “pings” other wirelessly connected devices on the network. Each ping is counted. Ping Rx (Ping received) indicates how many pings have been received by other devices on the network.

## Exiting Menu Mode

There are two ways to exit Menu Mode:

- If you do not press the button, after 20 seconds it will revert to the main screen.
- Press the button until you reach “Exit.”

## Diagnostic Mode

In Diagnostic Mode, the BW RigRat provides information about the instrument, battery, pump, etc., as well as a list of installed sensors and information about them (expiration date, serial number, etc.). Most of these screens are useful only to service technicians.

## Enter Diagnostic Mode

When the instrument is off, press and hold the button for more than 10 seconds after the 3-second countdown. The instrument starts self-testing and then enters Diagnostic Mode. In Diagnostic Mode, briefly press the button to navigate through the screens of instrument status, test LCD, LED, buzzer and pump.

## Navigating Diagnostic Mode

Step through Diagnostic Mode by pressing the button. The first screen shows information about the product, including the serial number, firmware version, etc. Exit Diagnostic Mode at any time by shutting the instrument off at this screen (hold the button for the 3-second countdown).

- Instrument model name and ID number (in hexadecimal)
- Serial number
- Instrument firmware Version
- Firmware build date
- Firmware build time
- RTC
- Sensors Installed
- Socket Raw Counts (for all enabled sensors)
- Sensors Serial Number
- Sensors Zero and Span raw counts
- Sensors produced date and warranty
- Battery capacity/voltage/current/temperature/SOH/cycle counts
- Battery current at idle mode (Hold button to enter idle mode and calculate)
- RAEMet readings (if installed)
- Noise sensor information (if installed. Hold to start calibration.)
- GPS information (if installed)
- LCD test (Hold to start test procedure.)
- LED and Buzzer test (Hold to start test procedure)
- Switch output/Digital input/4~20mA information (Hold to test switch output.)



# Exit Diagnostic Mode

In Diagnostic Mode, press the button to navigate to the following screen. If you hold the button now, the screen displays “OFF”. Release the button. The instrument is now off.

RigRat Pump  
BWRR-100P  
HRRDxxxxxxxx  
0105xxxx  
V1.00A  
Mar 20 2019  
14:30:24  
2019/03/29 13:35:20

RigRat Diffusion  
BWRR-100D  
HRRDxxxxxxxx  
0105xxxx  
V1.00A  
Mar 20 2019  
14:30:24  
2019/03/29 13:35:20

HOLD to power off

HOLD to power off





**Note:** Keep holding the button down at this screen for 10 seconds. The BW RigRat will ask for the 4-digit password. When the correct password is used, the BW RigRat enters normal operation mode with diagnostic mode datalogging.

# 12 Programming

## Using Device Configurator

The Honeywell Device Configurator Mobile App for mobile devices provides easy control over the BW RigRat's settings and functions. After pairing the BW RigRat with your mobile device, change settings, manage firmware updates, examine datalogs, upload configuration data, and more.

Download the free Device Configurator Mobile App. Then follow the instructions for installation.

Android	iOS
	
	

Go to Device List to see which devices are paired. Click Scan.

If your BW RigRat is in the Paired Devices list, click on it. When it connects, it says, "Connected."

You can disconnect from a paired device by clicking its name. A confirmation box is shown. Click "OK" to disconnect.

# Security Mode

Different types of wireless security guard your network against possible instances of unauthorized access. Using security, you can:

- Ensure that no one can easily connect to your wireless network without permission
- Personalize access regarding who can configure your wireless settings
- Protect all data that is transmitted through the wireless network

Check with your system administrator for the wireless security mode you should use. Then set your Security Key.

**Warning!** Using a network with security disabled is not recommended.

# 13

## Calibration and Testing

### Bump Testing and Calibration

To ensure greatest accuracy and safety, only bump test and calibrate in a fresh air environment.

The monitor should be calibrated every time it does not pass a bump test, but no less frequently than every six months, depending on use and exposure to gas and contamination, and its operational mode.

- Calibration intervals and bump test procedures may vary due to national legislation.
- Honeywell recommends using calibration gas cylinders containing the gas that is appropriate to the sensor you are using, and in the correct concentration.

When a bump test is done manually, the instrument makes a pass/fail decision based on sensor performance, but the user still has the responsibility to make sure all the alarms are enabled and functional.

### Bump (Functional) Testing

The same gas is used for a bump test as for calibration. A constant-flow regulator producing 0.5 liters per minute should be used, and the calibration adapter must be installed on the diffusion model of the BW RigRat. The instrument must be connected to a cylinder of calibration gas with supplied tubing.

**Note:** If LEL% and VOL% sensors are installed always bump test the LEL% sensor first.

1. Turn on your BW RigRat by pressing and holding the button, and allow the instrument to boot up fully until the main measurement screen with sensor names and readings is shown.

**Important!** Make sure all of the instrument's sensors have warmed up before performing a bump test. The instrument will take the time to warm up the sensors prior to enabling access to bump test menus. You can tell a sensor has warmed up if you see a reading next to its name on the display. If it has not warmed up, you see three dashes ("---") next to it.

2. **Diffusion:** Install the calibration adapter on the BW RigRat by setting it on over the sensors and pressing until it is snug against the surface of the instrument.

**Pumped:** Connect tubing from the filter's inlet to the regulator on the gas cylinder.

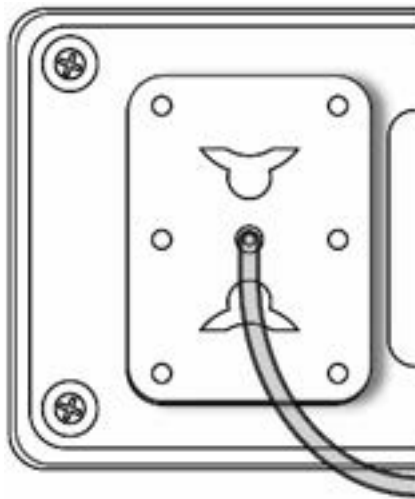

Diffusion

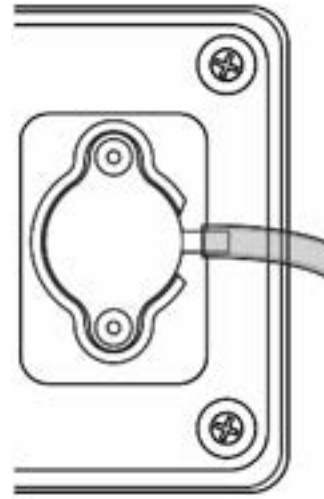

Pumped

3. To start the bump test, hold the button for 3 seconds at the “Bump Due” screen.
4. The 3-color LED and buzzer will activate (this tests the alarms).
5. Hold the button for 3 seconds if the audible and visible alarms are fully functional. Otherwise, press the button once to confirm that you understand there are faults.
6. After the audio-visual test, bump test, the instrument is ready for the bump testing.
7. Mount the calibration adapter and apply gas when the display shows “Apply test gas now.” Otherwise, the bump test will fail. Also, it may be necessary to change gas cylinders to provide the necessary gas for each sensor bump test.

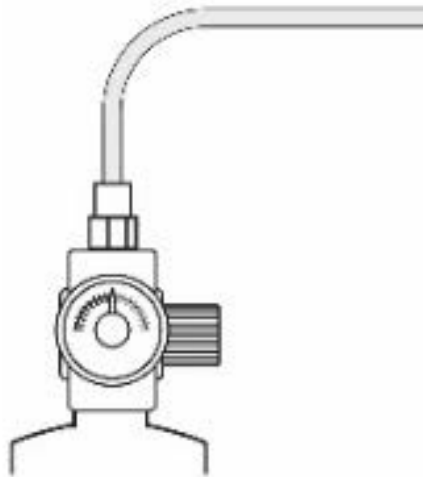

8. When the test is complete, test results are shown on the display.

00:00 AM 03/15/16 95%

**Next Bump Test**

LELIR®	1	days
OXY	1	days
CO	1	days
CO2	1	days
SO2	1	days
H2S	1	days

HOLD to start bump test →

Starting bump test

3

Keep holding →

Bump test Started



REFER TO USER'S MANUAL TO AVOID CROSS-SENSITIVITY

Audio-Visual TEST →

Did you see and hear the alarms?

Audio-Visual Test Passed



Apply test gas now



REFER TO USER'S MANUAL TO AVOID CROSS-SENSITIVITY

Timeout in 300 secs...

HOLD to accept

Click to decline →

CLICK to end →

Apply gas

Bump test Complete

Bump test Ended

<input type="checkbox"/> LELIR®	<input type="checkbox"/> OXY
<input type="checkbox"/> CO	<input type="checkbox"/> CO2
<input type="checkbox"/> SO2	<input type="checkbox"/> H2S

<input checked="" type="checkbox"/> LELIR®	<input checked="" type="checkbox"/> OXY
<input checked="" type="checkbox"/> CO	<input checked="" type="checkbox"/> CO2
<input checked="" type="checkbox"/> SO2	<input checked="" type="checkbox"/> H2S



CLICK to cancel →

Audio-Visual TEST →

If the Audio-Visual test fails or some sensors fail their bump test, the display will show results like this:

Audio-Visual Test  
Failed

Bump test  
Complete



✓ LELIR®	! OXY
✓ CO	! CO2
! SO2	✓ H2S

---

! Audio-Visual TEST

**Important!** Gas must be applied only after BW RigRat shows “Apply test gas now.” Otherwise, the bump test will fail.

**Important!** If one or more sensors fails a bump test, be sure to calibrate those sensors.

The bump test is now complete.

If all the alarms and all sensors have passed and no sensor is due for a calibration, the instrument is now ready for use.

# Calibration

This operation sets the zero and span points of the sensor calibration curve.

**Note:** If LEL% and VOL% sensors are installed, always calibrate the LEL% sensor first.

**Note:** If the device has failed calibration multiple times, the sensors will shut off and the screen will appear blank.

1. Hold the button for 3 seconds at main screen for the 3-second countdown.
2. After 3-second countdown for power off, keep holding the button, and the screen shows another 3-second countdown for entering Menu Mode.
3. Enter the password and accept the number.
4. Press the button to advance to the next menu.
5. Press and hold the button for 3 seconds to enter calibration.
6. Press the button to start zero calibration.

**Note:** If the BW RigRat has CO<sub>2</sub> or Oxygen sensor, after zero of fresh air, it will continue to nitrogen for a zero calibration.

7. Install the calibration adapter and apply nitrogen.
8. Turn off the gas or remove the calibration adapter when the nitrogen calibration completed.
9. Install the calibration adapter again and apply span gas to continue span calibration.



# 14 Maintenance

The BW RigRat requires little maintenance, aside from replacing sensors and filters. Maintenance and service shall only be performed by trained personnel and following the Honeywell guidelines provided in Honeywell training programs.

## **IMPORTANT!**

Honeywell cannot guarantee the IP rating of an instrument that has been opened and not reassembled according to instructions.

## **Cleaning**

Use water and a soft cloth to clean the BW RigRat. Do not use detergents or solvents. Do not submerge the instrument underwater.

# Antenna Installation

Attach the antenna by opening the compartment, aligning the antenna, and turning the base of the antenna until it is snug. (Tighten by turning clockwise, and loosen by turning counterclockwise.)

A number is marked on the antenna body for easy identification:

Description	P/N	Mark on body
Antenna 868-928MHz, RP-N**	550-7056-000	0188-1101
Antenna 2.4GHz, RP-N**	550-7057-000	0188-3101

\*\* Depends on wireless modem (if installed).



Antenna

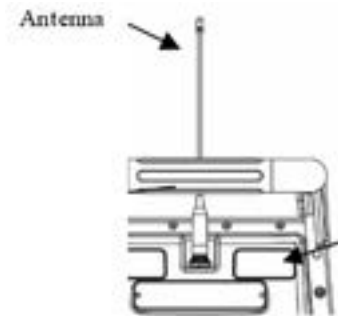

## IMPORTANT!

Make sure the antenna type is correct, or wireless communication distance will be reduced. Always tighten the antenna completely. Failure to do so will result in reduced communication distance.

# Removing Sensors



Do not replace sensors in hazardous locations.

All sensors are located inside the sensor compartment on the rear of the instrument. To access the sensors:

1. Turn off the instrument.
2. Remove the four screws that hold the sensor cover.

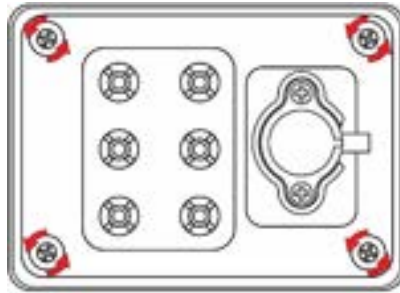

3. Lift off the cover.



4. Carefully lift out each sensor you wish to inspect or replace.

Sensor slots are keyed so that they can only accommodate specific types of sensors:

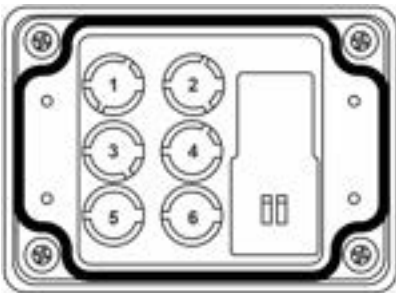

- 1 Slot 1: IR, IR low-power, or CO<sub>2</sub>
- 2 Slot 2: PID or IR or CO<sub>2</sub> or EC
- 3 Slot 3: Catalytic combustion LEL or EC
- 4 Slot 4: IR or CO<sub>2</sub> or EC
- 5 Slot 5: EC
- 6 Slot 6: EC

## Replacing Sensors

1. Gently lift out the desired sensor module with your fingers. If it is seated very tightly in the socket, do not pull it with heavy force. Gently rock it slightly back and forth while lifting.
2. Install the replacement sensor. It can only go into its slot one way. The connector inside the instrument and the indexing guides are good visual indicators of how to set the sensor into position. Make sure the indexing keys are aligned and press the sensor into place to ensure it is seated firmly.

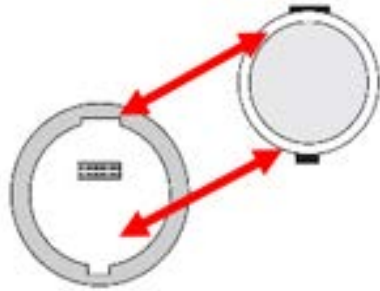

Match index keys on sensor module with socket



Sensor indexing key

3. Replace the cover and tighten the four screws.



It is extremely important that sensors are installed in the correct orientation. When installing a new sensor, the plastic film should be on top of the sensor. Once the sensor is installed, remove the plastic film.

**IMPORTANT!** Always perform a full calibration after replacing sensors.

## Battery Replacement

If the two rechargeable batteries ever need replacement, the work should only be performed by those trained by Honeywell to service this instrument. Replacements should only be of the same type: P/N 500-0165-000 (or 500-0165-001 for NA certification).

**WARNING!** Do not replace battery in hazardous locations.

# Replacing the Pump

If the pump requires replacement, follow this procedure. The pump assembly part number is P/N: W03-3016-000.

1. Turn off the BW RigRat.
2. Remove the four screws that hold the sensor compartment cover.

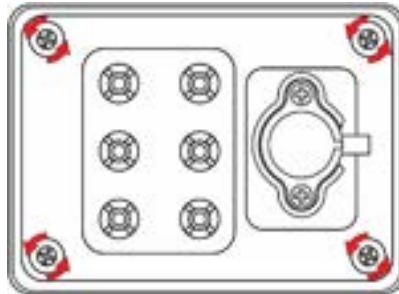

3. Lift off the sensor compartment cover and turn it over.

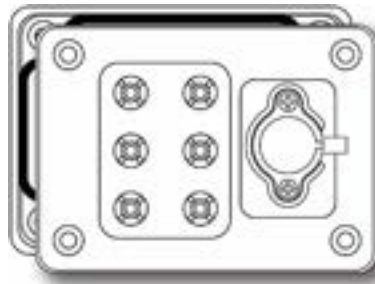

4. Remove the four screws that hold the pump assembly.

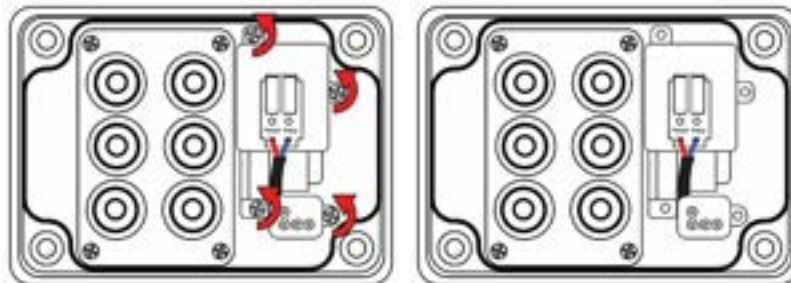

5. Lift the pump assembly from the side farthest from the gas plate and slightly pull it away from the gas plate.

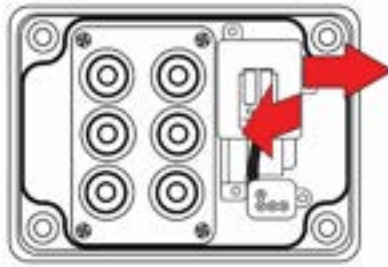

6. Remove the pressure sensor block by pulling it away from the pump.

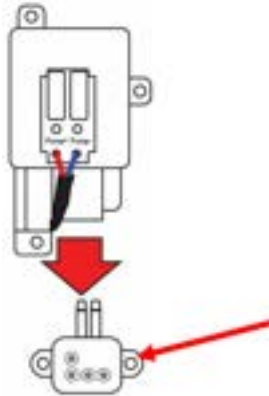

7. Attach the pressure sensor block to the new pump by pressing it into place.
8. Install the pump assembly. Note that the two inlets to the inlet and outlet for the pump require tilting the pump assembly when you reassemble the system.

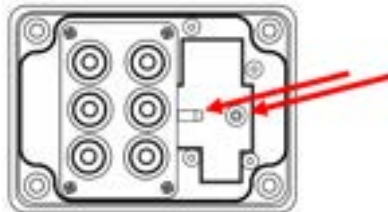

9. Reverse the disassembly process to reassemble the system.
10. When you are sure all parts are secure, turn on the instrument and test the pump to ensure that it is operational.

### IMPORTANT!

After replacing a pump, perform a pump test and perform a full calibration.

# 15 RAEMet Sensor Installation

## Installation

**Note:** Not intended to be used in explosive atmospheres

If your BW RigRat is equipped with a RAEMet meteorological sensor (P/N: W03-3045-000), it is typically removed for storage and must be attached before using it.

1. If the BW RigRat is on, turn it off. (Never attach or remove the RAEMet sensor without first turning off the instrument's power.)
2. Attach the RAEMet to the instrument's handle using the two U-shaped bolts and the wingnuts. Then attach the sensor to the bracket.

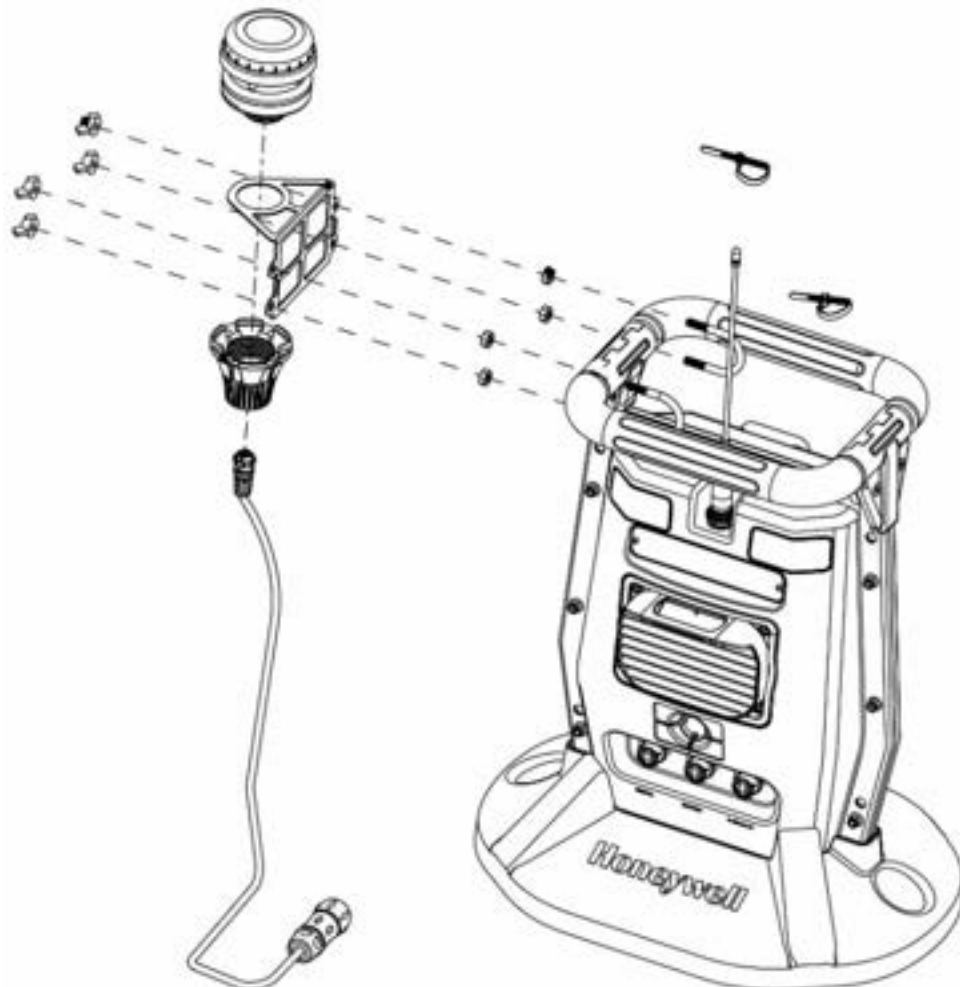

3. Remove the cover over the Serial receptacle.



4. Align the RAEMet's connector plug with the BW RigRat's receptacle using the indexing keys and slots as a guide.



Note locations of indexing slots in receptacle

5. Press the RAEMet's base into place, and then turn the locking ring to tighten the connection. Never force the connector in or out of the receptacle.
6. Tighten the locking ring until the RAEMet sensor is firmly seated. Do not turn the entire RAEMet sensor.

### IMPORTANT!

If the RAEMet and BW RigRat's receptacle are not aligned properly, electrical connections will not be made and the RAEMet sensor will not operate. Also, when the RAEMet sensor is not attached to the instrument, make sure the cover is securely closed to keep moisture and debris from entering the base.

**Note:** Do not remove the RAEMet sensor from the instrument while it is in operation.

**Note:** Keep strong magnets away from the RAEMet sensor. It contains a compass, and strong magnetism can affect its accuracy.



# 16

## Alarms Overview

The BW RigRat provides audible and visible alarm notification system, plus it combines local alarms on the device with real-time remote wireless alarm notification to enhance worker safety. Local alarms include audible buzzer alarm, visible alarm via bright LED lights, and an alarm notification on the display. The audible alarm can be programmed or selectively turned on or off. The LED alarm indicators cannot be turned off.

### Alarm Signals

During each measurement period, the gas concentration is compared with the programmed alarm limits for Low, High, TWA and STEL alarm. If the concentration exceeds any of the preset limits, the alarms are activated immediately to warn of the alarm condition.

In addition, the BW RigRat alarms if the battery voltage is low.

When the low battery alarm occurs, it is recommended that you promptly charge the battery in a non-hazardous location.

# Alarm Signal Summary

## Normal Operation Mode

Type	Red LED	Yellow LED	Green LED	Buzzer	LCD Display	Reading	Notes
Over Range	5 beeps/s			600ms/s	"+OL"	Blink red	
High	3 beeps/s			400ms/s	High alarm icon and reading	Blink red	
Low	2 beeps/s			200ms/s	Low alarm icon and reading	Blink red	
STEL	1 beep/s			200ms/s	STEL alarm icon and reading	Blink red	
TWA	1 beep/s			200ms/s	TWA alarm icon and reading	Blink red	
Unit Failure		3 beeps/s		200ms/s			Instrument fatal error
Fail		2 beeps/s		200ms/s	"FAIL"	Blink red	Sensor generic fail
Negative		1 beeps/s		200ms/s	"-OL"	Blink red	
PID Lamp		1 beeps/s		200ms/s	"LAMP"	Blink red	PID lamp fail
Remote Alarm		1 beeps/s		200ms/s	Units in alarm in network detail screen		Remote device alarm in closed loop network
External Alarm		1 beeps/s		200ms/s	External signal state in "Input/output state" screen		4~20mA input, digital input
Pump		1 beeps/s		200ms/s	Blink pump icon		
Battery critical		1 beeps/s		200ms/s	Battery critical icon		Battery voltage less than 3 to 3.5V for 4s, unit will power off in 15 minutes. The voltage threshold is

Type	Red LED	Yellow LED	Green LED	Buzzer	LCD Display	Reading	Notes
							temperature compensated under 0 deg
Battery low		1 beeps/s			Battery low icon		
Warm up		1 beeps/s			"Sensor warming up" screen		
Cal Fail		Reverse IntelliFlash		Confidence beep	Cal error icon at bottom of screen		
Bump Fail		Reverse IntelliFlash		Confidence beep	Bump error icon at bottom of screen		
Cal Due		Reverse IntelliFlash		Confidence beep	Cal error icon at bottom of screen		
Bump Due		Reverse IntelliFlash		Confidence beep	Bump error icon at bottom of screen		
Datalog Full		Reverse IntelliFlash		Confidence beep			Datalog memory is full
Network Lost		Reverse IntelliFlash		Confidence beep	Network error icon		
Compliance			IntelliFlash	Confidence beep			When device is in compliance state
Network Action			1 beep	200ms	Show network icon		

Program/Menu/Configuration Mode

Type	Red LED	Yellow LED	Green LED	Buzzer	LCD Display	Reading	Notes
Program mode		1 beeps/s			In menu or configuration screens		For bump/cal operation, changing configuration
Hardware test	Hardware test pattern	Hardware test pattern	Hardware test pattern	Hardware test pattern			

Device Startup

Type	Red LED	Yellow LED	Green LED	Buzzer	LCD Display	Reading
Startup	Startup pattern	Startup pattern	Startup pattern	Startup pattern		

## Manual Alarms Test

Under Normal Operation Mode and non-alarm conditions, the buzzer (audible alarm) and visible alarms can all be tested anytime by turning off the instrument or bump testing the instrument. If any alarm does not respond, check the alarm settings to make sure all alarms are enabled. If any alarms are enabled but not functional, the instrument should not be used. Contact Technical Support.

## 17

## Troubleshooting

Problem	Possible Reasons & Solutions
Cannot connect to Device Configurator	<p>Bluetooth not open.</p> <p><b>Reasons:</b> Password error. Old version of Device Configurator.</p> <p>Enable Bluetooth in the mobile phone. Contact authorized service center.</p> <p><b>Solutions:</b> Update Device Configurator software. Find the Bluetooth from the mobile phone setting, and delete it. Then re-establish the link with the instrument.</p>
Cannot turn on power after charging the battery	<p><b>Reasons:</b> Defective charging circuit. Defective battery.</p> <p><b>Solutions:</b> Try charging the battery again. Call authorized service center.</p>
Lost password	<p><b>Solutions:</b> Call Technical Support</p>
Buzzer, LED lights inoperative	<p><b>Reasons:</b> Buzzer disabled. Bad buzzer or LED light.</p> <p>Check LCD if the “buzzer disabled” icon blinks. Use Device Configurator App to set Buzzer and Light All On.</p> <p><b>Solutions:</b> Contact authorized service center.</p>
“Lamp” message when power on. Lamp alarm.	<p><b>Reasons:</b> Low ion concentration inside PID lamp, especially in cold environment when first powered on. Defective PID lamp or defective circuit.</p> <p><b>Solutions:</b> Turn the unit off and back on. Replace UV lamp.</p>
Pump failed message. Pump alarm.	<p>Inlet probe blocked. Direct connection to a gas outlet while the gas valve is turned off.</p> <p><b>Reasons:</b> External filter sucks in water. External filter too dirty. Water condensed along the inlet probe. Bad pump or pump circuit.</p> <p><b>Solutions:</b> Remove the blocking objects and then press the button to reset the pump alarm. Replace contaminated water trap filter. Be careful not to allow water condensation inside the unit. Replace the pump.</p>
BW RigRat LCD has no response when AC	<p><b>Reasons:</b> Bad AC charger or AC charger plug to BW RigRat not well connected; Long storage causes battery low capacity and self-</p>

Problem	Possible Reasons & Solutions
charger is connected	<p>protection.</p> <p>Try another AC charger or connect again. The BW RigRat</p> <p><b>Solutions:</b> requires time to trickle charge the battery first before it can run normally and show messages on the LCD.</p>

If you need replacement parts, please contact an authorized Honeywell distributor.

# 18

## Editing Features

Some features can be turned on or off or edited directly on the BW RigRat, some can only be accessed through the Device Configurator app, and some can be accessed and changed through both. This table shows where features can be accessed.

Feature	BW RigRat	Device Configurator
Bump Test	✓	
Gas Calibration	✓	✓
Pump Calibration	✓	
Sensor On/Off	✓	✓
Set Span		✓
Set Sensor Units		✓
Set LEL Calibration Gas		✓
Set LEL Measurement Gas		✓
Get LEL/PID CF value		✓
Set PID Calibration Gas		✓
Set PID Measurement Gas		✓
Set Multi-Calibration Gas		✓
Set Gas Alarm Limits		✓
Get/Set bump test date and interval		✓
Get/Set calibration test date and interval		✓
Get/Set Alarm Mode		✓
Set Inert Mode		✓
Alarm Settings		✓
Secure Beep		✓
Set Intelli-Flash		✓
Set Intelli-Flash interval		✓
Set Reverse Intelli-Flash		✓
Set Reverse Intelli-Flash Interval		✓
Datalog Interval		✓
Datalog Sensor Selection		✓
Datalog Data Selection		✓

<b>Feature</b>	<b>BW RigRat</b>	<b>Device Configurator</b>
Datalog Type		✓
Datalog Action When Full		✓
Datalog Automatic Interval		✓
Set Date		✓
Set Time		✓
Backlight		✓
Set Site ID		✓
Set User ID		✓
Zero At Start		✓
Radio On/Off		✓
Mesh Radio Network Type		✓
Set PAN ID		✓
Set Channel		✓
Set Wireless Interval		✓
Off Network Alarm		✓
Get Bluetooth MAC address		✓
GPS On/Off		✓
Wi-Fi On/Off		✓
Set Access Point SSID		✓
Set Access Point Password		✓
DHCP Enable		✓
Set Server IP Address		✓
Set Server Port		✓
Set Network Security On/Off		✓
Set Network Security Keys		✓
Security Mode		
Noise Sensor On/Off		✓
Get gas library information		✓
Get/Set custom gas list		✓
Get/Set password		✓
Get/Set secure level		✓
Set power up welcome message		✓
Get/Set LCD idle timeout		✓
Get/Set LCD backlight mode		✓
Get/Set LCD backlight level		✓
Get/Set LCD color mode		✓
Get/Set language		✓



<b>Feature</b>	<b>BW RigRat</b>	<b>Device Configurator</b>
Set Switch Outputs		✓
Set Digital Input On/Off		✓
Set Digital Input Alarm Point		✓
Set 4~20mA Input On/Off		✓
Set 4~20mA Alarm Points		✓
Policy Enforcement (force on calibration/bump)		✓
Average Type		✓
DC security		✓

## Error Codes

Type	Code	Display message	Key	Action	Note
Forbidden Error	5001	Battery Critical Low		Powering off...	Power off in 3 seconds after this message
	5002	Battery Too Hot		Powering off...	Power off in 3 seconds after this message
	5003	Battery Module No Response		Powering off...	Power off in 3 seconds after this message
Fatal Error	4002	Contact your distributor	Hold to power off	Power off in 300s	Unknown product model
	4003	Contact your distributor	Hold to power off	Power off in 300s	Application instrument ID set for service mode
	4004	Contact your distributor	Hold to power off	Power off in 300s	Sensor instrument ID does not match application module
	4005	Contact your distributor	Hold to power off	Power off in 300s	Sensor instrument ID set for service mode
	4006	Contact your distributor	Hold to power off	Power off in 300s	No response from sensor module
	4008	Contact your distributor	Hold to power off	Power off in 300s	Incompatible sensor and application firmware
	4011	Contact your distributor	Hold to power off	Power off in 300s	Bad battery (Battery voltage too high or too low during charging)
	4013	Contact your distributor	Hold to power off	Power off in 300s	No battery (Power supplied from AC adapter)
	4015	Contact your distributor	Hold to power off	Power off in 300s	Lost communication
	4017	Contact your distributor	Hold to power off	Power off in 300s	Input wrong password 5 times
Critical Error	3001	RTC Error	Click to acknowledge	Power off in 300s	
	3003	Pump not found	Click to acknowledge	Power off in 300s	Reinstall Pump
	3005	Gas plate not installed	Click to acknowledge	Power off in 300s	Reinstall Gas Plate
Normal Error	2001	Failed to Turn on Lamp	Click to acknowledge	Power off in 300s	Cannot turn on PID lamp
Message	1001	Datalog Link Broken	Click to acknowledge	Power off in 300s	Datalog is broken
	1005	Unsupported Sensor Found and Deactivated	Click to acknowledge	Power off in 300s	Check sensor installed. See "Replacing Sensors" on page 83 for more information.

<b>Type</b>	<b>Code</b>	<b>Display message</b>	<b>Key</b>	<b>Action</b>	<b>Note</b>
	1006	TH Module Not Found	Click to acknowledge	Power off in 300s	Reinstall TH Module
	1007	Datalog Flash Not Found	Click to acknowledge	Power off in 300s	Datalog memory broken or missing
	1008	Bluetooth (BLE) not Found	Click to acknowledge	Power off in 300s	Bluetooth (BLE) module not found
	1009	GPS Not Found	Click to acknowledge	Power off in 300s	GPS module not found
	1010	Wireless Module Not Match Configuration	Click to acknowledge	Power off in 300s	Invalid wireless configuration
	1011	Mesh Module Not Found	Click to acknowledge	Power off in 300s	
	1013	Wi-Fi Module Not Found	Click to acknowledge	Power off in 300s	
	1017	Battery Charging Current Too Low	Click to acknowledge	Power off in 300s	
	1018	Battery NTC Fault	Click to acknowledge	Power off in 300s	Temperature out of range, battery cannot charge
	1020	Forced to charge	Click to acknowledge	Power off in 300s	Battery voltage too low, power on with AC
	1022	RAEMet Not Found	Click to acknowledge	Power off in 300s	RAEMet sensor not found. Reinstall RAEMet to Serial receptacle.

# 19 Specifications

## Instrument Specifications

Size	15.75" x 11.4" x 18.5" (400 x 290 x 470 mm)
Weight	17.7 lbs (8 kg)
Gas Sensor Slots	Up to 6
Battery	Rechargeable Li-ion battery, 3.7V/26.4Ah Note: All battery specifications at 20° C; lower temperatures might affect runtime.
Display	3.5" 240 x 320 TFT color LCD with white LED backlight
Display Readout	<ul style="list-style-type: none"> <li>• Real-time reading of gas concentrations; battery status; datalogging on/off; wireless on/off and wireless reception quality.</li> <li>• STEL, TWA, peak, and minimum values</li> <li>• Policy enforcement indicator</li> <li>• GPS quality indicator (if GPS equipped)</li> </ul>
Keypad	1 pushbutton for operation and programming
Gas Sampling Method	Pumped (typical flow rate of 450cc/min) or Diffusion
Calibration	Device Configurator mobile application, or manual
Alarms	<ul style="list-style-type: none"> <li>• Red/Yellow/Green bright LED alarm</li> <li>• Buzzer alarm 108dBA @1m</li> <li>• On-screen indication of alarm conditions</li> </ul>
Datalogging	<ul style="list-style-type: none"> <li>• Gas sensors and GPS data at one minute interval for 4 months</li> <li>• Datalogging interval setting: 1 to 3600 sec (default: 1 min)</li> </ul>
Location	Outdoor, GPS, 10m accuracy, Optional
RF Power	Up to 4dBm/2.5mW(BLE); up to 17dBm/50mW (Mesh); up to 11dBm/12.5mW (Wi-Fi)
IP Rating	IP65 for Pumped; IP67 for Diffusion.
Operating Temperature	-20°C to +60°C (-4°F to 140° F) for Pumped; -40°C to +60°C (-40°F to 140° F) for Diffusion, depending on sensor specification.
Humidity	5% to 95% RH Non-Condensing
Safety Certifications	IEC Ex No: IECEx NEP 20.0003X Ex ia IIC/IIB T4; Ga Ex da ia IIC/IIB T4; Ga Ex db ia IIC/IIB T4 Gb ATEX No: SEV 20 ATEX 0389 X II 1G Ex ia <b>II</b> / <b>IB</b> T4 G; II 1G Ex da ia <b>II</b> / <b>IB</b> T4 Ga; II 2G Ex db ia

	<b>IC/IB T4 Gb</b> North American: cETLus Class I, Division 1, Groups A, B, C, & D, T4; Class I, Division 1, Groups C, & D, T4
Performance Tests	Performance Requirements of Detectors for Flammable Gases UL 60079-29-1:2019 Ed.2 CAN/CSA C22.2 NO. 60079-29-1:17 Ed.2
Wireless Approvals	FCC Part15; IC; RE-D (2014/53/EU) (Contact us for wireless approval availability, country-specific)
RoHS	RoHS Directive (EU) 2015/863
Noise Sensor	60 to 125dBA range (Response: 100Hz to 8kHz), 1dB resolution A-weighted 15 second equivalent level. Updated every 5 seconds
External Ports	Serial communication, switching, and 4-20mA Input
Safe Area Charge Port (AC CHG SAFE AREA)	Battery charger input, DC5.7V 3A typical; Connect to AC/DC adapter.
Field charge from IS Barrier/Solar Panel (IS CHG HAZARDOUS)	Line Power Supply input to extend Instrument Runtime. For Low Power version only.
RAEMet Port (Serial)	Optional; Port to RAEMet wind sensor.
Analog/Switch Input Port (4-20MA IN)	Optional; 4-20mA signal input, X1 channel /Switch on/off signal input, X1 channel
Relays Driver Output (SWITCH)	Optional; Optocoupler, SPDT Normal Open, X3 channels
Languages	English, German, Spanish, Portuguese, Russian, Chinese, French, Arabic
Warranty	<ul style="list-style-type: none"> <li>• Two years on LEL, CO, H2S, and O2 sensors</li> <li>• One year on other sensors</li> </ul>

Specifications are subject to change.

## Supported Sensors

<b>Gas Type</b>	<b>Range</b>	<b>Resolution</b>	<b>Temperature Range</b>
COMBUSTIBLE GASES (IR-LP)	0-100%LEL	1%LEL	-40 to +140° F / -40 to +60° C
COMBUSTIBLE GASES (IR-LP)	0-100%VOL	0.1%VOL	-40 to +140° F / -40 to +60° C
COMBUSTIBLE GASES (IR)	0-100%LEL	1%LEL	-4 to +131° F / -20 to +50° C
COMBUSTIBLE GASES (IR)	0-100%VOL	0.1%VOL	-4 to +131° F / -20 to +50° C
COMBUSTIBLE GASES (LEL)	0-100%LEL	1%LEL	-40 to +140° F / -40 to +60° C
CARBON DIOXIDE (CO <sub>2</sub> )	0-5%VOL/0-50000ppm	0.01%VOL/100ppm	-4 to +131° F / -20 to +50° C
CARBON DIOXIDE (CO <sub>2</sub> ) (EXT. RANGE)	0-100%VOL	0.1%VOL	-4 to +131° F / -20 to +50° C
VOLATILE ORGANIC COMPOUNDS (VOC)	0-2000ppm	0.1ppm	-4 to +131° F / -20 to +50° C
CARBON MONOXIDE (CO)	0-500ppm	1ppm	-40 to +140° F / -40 to +60° C
CARBON MONOXIDE (CO) (EXT. RANGE)	0-2000ppm	10ppm	-4 to +131° F / -20 to +50° C
CARBON MONOXIDE (CO) (H <sub>2</sub> RESISTANT)	0-2000ppm	5ppm	-4 to +131° F / -20 to +50° C
HYDROGEN SUFLIDE (H <sub>2</sub> S)	0-100ppm,	0.1ppm	-40 to +140° F / -40 to +60° C
HYDROGEN SUFLIDE (H <sub>2</sub> S) (EXT. RANGE)	0-1000ppm	1ppm	-4 to +131° F / -20 to +50° C
SULFUR DIOXIDE (SO <sub>2</sub> )	0-20ppm	0.1ppm	-4 to +131° F / -20 to +50° C
OXYGEN (O <sub>2</sub> )	0-30%VOL	0.1%VOL	-4 to +131° F / -20 to +50° C
NITRIC OXIDE (NO)	0-250ppm	0.5ppm	-4 to +131° F / -20 to +50° C
NITROGEN DIOXIDE (NO <sub>2</sub> )	0-20ppm	0.1ppm	-4 to +131° F / -20 to +50° C
HYDROGEN CYANIDE (HCN)	0-50ppm	0.5ppm	-4 to +131° F / -20 to +50° C
AMMONIA (NH <sub>3</sub> )	0-100ppm	1ppm	-4 to +131° F / -20 to +50° C
CHLORINE (CL <sub>2</sub> )	0-50ppm	0.1ppm	-4 to +131° F / -20 to +50° C

All specifications are subject to change without notice.

#### LEL Range, Resolution & Response Time

##### Range

0 to 100% LEL

##### Resolution

1%

##### Response Time:

T90 < 30 sec.

##### Caution:

Refer to Technical Note TN-114 for LEL sensor cross-sensitivities.

Refer to Technical Note TN-144 for LEL sensor poisoning.

## Year Of Manufacture

To identify the year and month of manufacture, refer to the two-digit marking placed adjacent to the serial number on the instrument label according to the following table:

<b>Year</b>	<b>First digit Year code</b>	<b>Month</b>	<b>Second digit Month code</b>
2014	R	January	1
2015	S	February	2
2016	T	March	3
2017	U	April	4
2018	V	May	5
2019	W	June	6
2020	A	July	7
2021	B	August	8
2022	C	September	9
2023	D	October	A
2024	E	November	B
2025	F	December	C

Example: "RA" indicates that the monitor is manufactured in the month of October in the year 2014.



### Sensor Parameters Edit Range

<b>Parameter</b>	<b>Unit</b>	<b>Minimum</b>	<b>Maximum</b>	<b>Default</b>
CO Span	ppm	1	500	50
CO Sensor Range	ppm	1	1000	N/A
CO Low	ppm	1	1000	35
CO High	ppm	1	1000	200
CO STEL	ppm	1	1000	100
CO TWA	ppm	1	1000	35
H <sub>2</sub> S Span	ppm	1	100	10
H <sub>2</sub> S Sensor Range	ppm	1	100	N/A
H <sub>2</sub> S Low	ppm	1	100	10
H <sub>2</sub> S High	ppm	1	100	20
H <sub>2</sub> S STEL	ppm	1	100	15
H <sub>2</sub> S TWA	ppm	1	100	10
LEL Span	%LEL	10	60	50
LEL Sensor Range	%LEL	1	100	N/A
LEL Low	%LEL	10	60	10
LEL High	%LEL	10	60	20
O <sub>2</sub> Span	%	1	30	18
O <sub>2</sub> Sensor Range	%	1	30	N/A
O <sub>2</sub> Low	%	1	30	19.5
O <sub>2</sub> High	%	1	30	23.5
HCN Span	ppm	1	50	10
HCN Sensor Range	ppm	1	50	N/A
HCN Low	ppm	1	50	4.7
HCN High	ppm	1	50	25

# 20

## Contact Information

For more information

<https://sps.honeywell.com>

### **CORPORATE HEADQUARTERS**

700 Mint St.

Charlotte, NC 28202, USA

For BW:

Toll free: +1 800 538 0363

Email: [detectgas@honeywell.com](mailto:detectgas@honeywell.com)

For RAE:

Toll free: +1 888 749 8878

Email: [rae-callcenter@honeywell.com](mailto:rae-callcenter@honeywell.com)

### **RAE HEADQUARTERS**

RAE Systems by Honeywell

1349 Moffett Park Drive

Sunnyvale, CA 94089 USA

Phone: 408.952.8200

[RAE-tech@honeywell.com](mailto:RAE-tech@honeywell.com)

### **WORLDWIDE SALES OFFICES**

USA/Canada 1.877.723.2878

Europe +800.333.222.44/+41.44.943.4380

Middle East +971.4.450.5852

China +86.10.5885.8788-3000

Asia Pacific +852.2669.0828



User Manual P/N: W03-4001-000

BW RigRat

Revision E

© Honeywell September 2022